



大功率 LED 路灯

High-power LED Street Light



BSD-LD008

产品特点 Product Features

模组化可插拔技术，免工具现场维护；蜂窝式散热，超高防水等级；多路恒流驱动电源，单一模组可热插拔；智能恒流驱动技术，突破电源寿命瓶颈；人类功效学配光，均匀道路照明；自由系列化，全功率解决方案。

Using modularization plug technology, on-site maintenance without tools. Cellular radiator of heating, high waterproof rating, multiple constant-current driving power, single module and can be hot-pluggable. Intelligent constant current drive technology, break through the bottleneck of the driver life. Human ergonomics distribution of light makes uniform road lighting. Assortment freely seriation and full power solutions.

应用场合 Applications

适用于城市道路、居住区、工业道路、人行道、公园、学校、别墅、庭院等道路照明。

Apply to arterial street, residential area, industrial park, sidewalk, square, park, school, villa area, yards, etc.

规格参数 Specifications

材料 Material	Al
防护等级 IP Rating	IP65
功率 Power (W)	80W
输入电压 Input Voltage (V)	85-265
光源类型 Light source Type	high power LED
芯片尺寸 Chip Size (mil)	45
光源数量 Light Source Quantity (pcs)	72
光源光效 Luminous Efficiency (Lm/W)	90-130
显色指数 CRI	80
色温 Color Temp (k)	2800-7000
环境温度 Environment Temperature (°C)	-40~45
使用寿命 Lifespan (h)	30000-80000



配光曲线 Light Distribution Curve

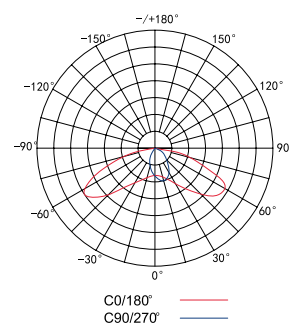

外形尺寸图 Dimension Diagram

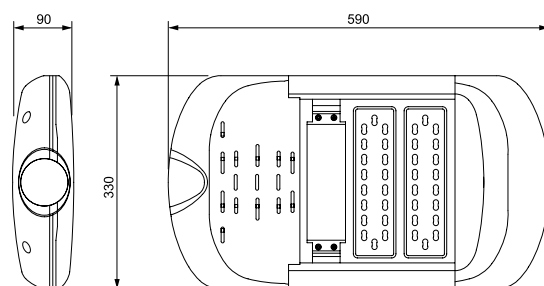

包装参数 Packaging Parameters

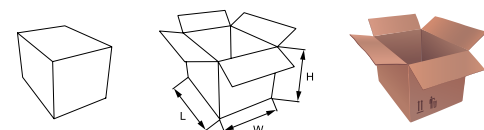

Item	Size(mm)	包装数量 Qty	外箱尺寸 Carton Size
BSD-LD008		1PC	685L×415W×150H



大功率 LED 路灯

High-power LED Street Light

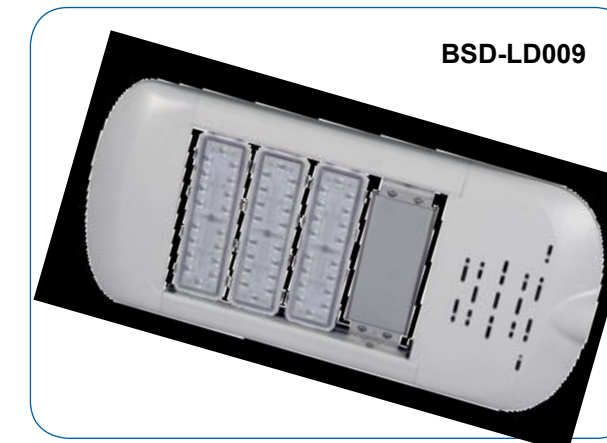

BSD-LD009

产品特点 Product Features

模组化可插拔技术，免工具现场维护；蜂窝式散热，超高防水等级；多路恒流驱动电源，单一模组可热插拔；智能恒流驱动技术，突破电源寿命瓶颈；人类功效学配光，均匀道路照明；自由系列化，全功率解决方案。

Using modularization plug technology, on-site maintenance without tools. Cellular radiator of heating, high waterproof rating, multiple constant-current driving power, single module and can be hot-pluggable. Intelligent constant current drive technology, break through the bottleneck of the driver life. Human ergonomics distribution of light makes uniform road lighting. Assortment freely seriation and full power solutions.

应用场合 Applications

适用于城市道路、居住区、工业道路、人行道、公园、学校、别墅、庭院等道路照明。

Apply to arterial street, residential area, industrial park, sidewalk, square, park, school, villa area, yards, etc.

规格参数 Specifications

材料 Material	Al
防护等级 IP Rating	IP65
功率 Power (W)	120W
输入电压 Input Voltage (V)	85-265
光源类型 Light source Type	high power LED
芯片尺寸 Chip Size (mil)	45
光源数量 Light Source Quantity (pcs)	108
光源光效 Luminous Efficiency (Lm/W)	90-130
显色指数 CRI	80
色温 Color Temp (k)	2800-7000
环境温度 Environment Temperature (°C)	-40~45
使用寿命 Lifespan (h)	30000-80000

配光曲线 Light Distribution Curve

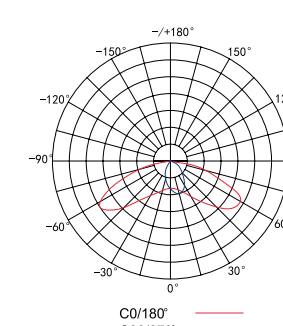

外形尺寸图 Dimension Diagram

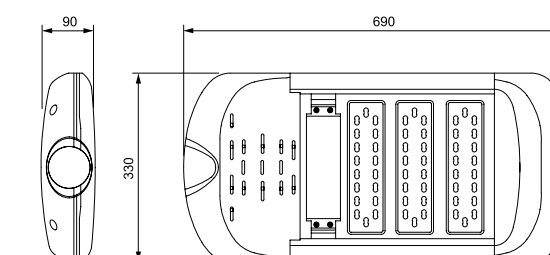

包装参数 Packaging Parameters

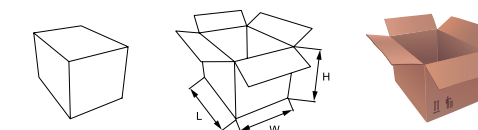

Item	Size(mm)	包装数量 Qty	外箱尺寸 Carton Size
BSD-LD009		1PC	775L×415W×150H



大功率 LED 路灯

High-power LED Street Light



BSD-LD010

产品特点 Product Features

模组化可插拔技术，免工具现场维护；蜂窝式散热，超高防水等级；多路恒流驱动电源，单一模组可热插拔；智能恒流驱动技术，突破电源寿命瓶颈；人类功效学配光，均匀道路照明；自由系列化，全功率解决方案。

Using modularization plug technology, on-site maintenance without tools. Cellular radiator of heating, high waterproof rating, multiple constant-current driving power, single module can be hot-pluggable. Intelligent constant current drive technology, break through the bottleneck of the driver life. Human ergonomics distribution of light makes uniform road lighting. Assortment freely seriation and full power solutions.

应用场合 Applications

适用于城市道路、居住区、工业道路、人行道、公园、学校、别墅、庭院等道路照明。

Apply to arterial street, residential area, industrial park, sidewalk, square, park, school, villa area, yards, etc.

规格参数 Specifications

材料 Material	Al
防护等级 IP Rating	IP65
功率 Power (W)	160W
输入电压 Input Voltage (V)	85-265
光源类型 Light source Type	high power LED
芯片尺寸 Chip Size (mil)	45
光源数量 Light Source Quantity (pcs)	144
光源光效 Luminous Efficiency (Lm/W)	90-130
显色指数 CRI	80
色温 Color Temp (k)	2800-7000
环境温度 Environment Temperature (°C)	-40~45
使用寿命 Lifespan (h)	30000-80000



配光曲线 Light Distribution Curve

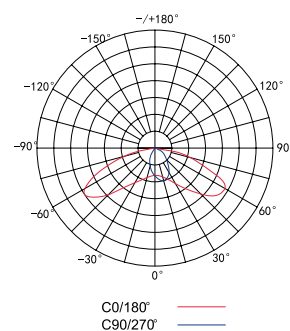

外形尺寸图 Dimension Diagram

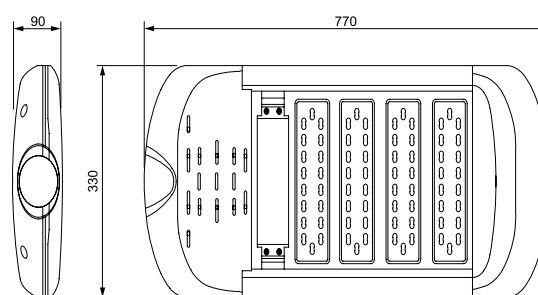

包装参数 Packaging Parameters

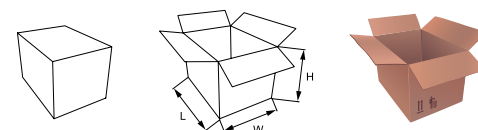

Item	Size(mm)	包装数量 Qty	外箱尺寸 Carton Size
BSD-LD010		1PC	865L×415W×150H



产品特点 Product Features

灯具的灯体及灯盖采用铝合金或铝合金压铸材料；透光体采用超白钢化玻璃，具有高强度、透光率好等特点；每颗LED配置独立二次光学系统，取光效率高达93%以上，产品体积小，重量轻，稳固性高，有效降低风阻，减轻灯杆的负荷，有利于抗风，安全可靠；充分体现“人性化”；整灯采用组合式设计。

Lamp body and cover adopt aluminum alloy or aluminum alloy die casting materials; Transmission body adopts ultrawhite toughened glass with features of high strength, excellent light transmission, etc. Each LED configured with independent secondary optical system, light extraction rate is over 93%; Small size, light weight, high stability, effectively reduce wind resistance and burden of lamp-post, it is helpful to wind resistance, safe and reliable; Fully demonstrate humanization; The lamp adopted with combined design.

应用场合 Applications

适用于城市道路、居住区、工业道路、人行道、公园、学校、别墅、庭院等道路照明。

Apply to arterial street, residential area, industrial park, sidewalk, square, park, school, villa area, yards, etc.

规格参数 Specifications

材料 Material	Al
防护等级 IP Rating	IP65
功率 Power (W)	28W
输入电压 Input Voltage (V)	85-265
光源类型 Light source Type	high power LED
芯片尺寸 Chip Size (mil)	45
光源数量 Light Source Quantity (pcs)	28
光源光效 Luminous Efficiency (Lm/W)	90-130
显色指数 CRI	80
色温 Color Temp (k)	2800-7000
环境温度 Environment Temperature (°C)	-40~45
使用寿命 Lifespan (h)	30000-80000

大功率 LED 路灯

High-power LED Street Light

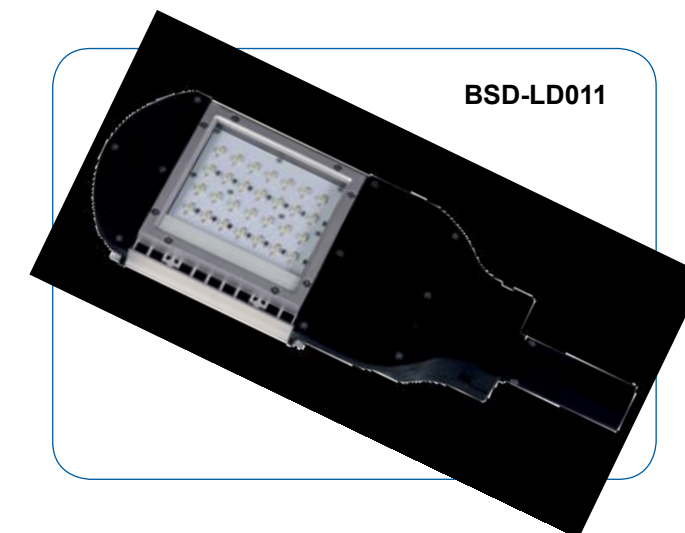

BSD-LD011

配光曲线 Light Distribution Curve

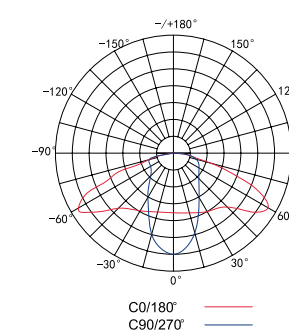

外形尺寸图 Dimension Diagram

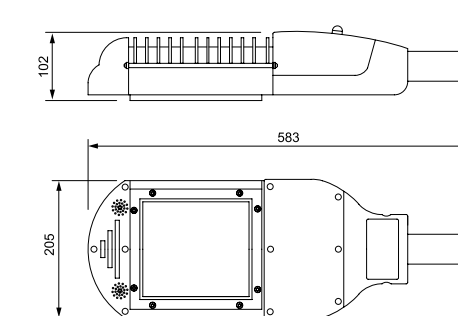

包装参数 Packaging Parameters

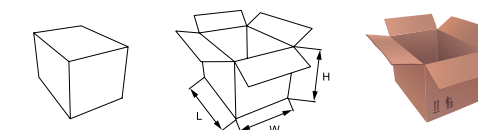

Item	Size(mm)	包装数量 Qty	外箱尺寸 Carton Size
BSD-LD011		1PC	680L×310W×200H



大功率 LED 路灯

High-power LED Street Light



BSD-LD012

产品特点 Product Features

灯具的灯体及灯盖采用铝合金或铝合金压铸材料；透光体采用超白钢化玻璃，具有高强度、透光率好等特点；每颗LED配置独立二次光学系统，取光效率高达93%以上，产品体积小，重量轻，稳固性高，有效降低风阻，减轻灯杆的负荷，有利于抗风，安全可靠；充分体现“人性化”；整灯采用组合式设计。

Lamp body and cover adopt aluminum alloy or aluminum alloy die casting materials; Transmission body adopts ultrawhite toughened glass with features of high strength, excellent light transmission, etc. Each LED configured with independent secondary optical system, light extraction rate is over 93%; Small size, light weight, high stability, effectively reduce wind resistance and burden of lamp-post, it is helpful to wind resistance, safe and reliable; Fully demonstrate humanization; The lamp adopted with combined design.

应用场合 Applications

适用于城市道路、居住区、工业道路、人行道、公园、学校、别墅、庭院等道路照明。

Apply to arterial street, residential area, industrial park, sidewalk, square, park, school, villa area, yards, etc.

规格参数 Specifications

材料 Material	Al
防护等级 IP Rating	IP65
功率 Power (W)	56W
输入电压 Input Voltage (V)	85-265
光源类型 Light source Type	high power LED
芯片尺寸 Chip Size (mil)	45
光源数量 Light Source Quantity (pcs)	56
光源光效 Luminous Efficiency (Lm/W)	90-130
显色指数 CRI	80
色温 Color Temp (k)	2800-7000
环境温度 Environment Temperature (°C)	-40~45
使用寿命 Lifespan (h)	30000-80000



配光曲线 Light Distribution Curve

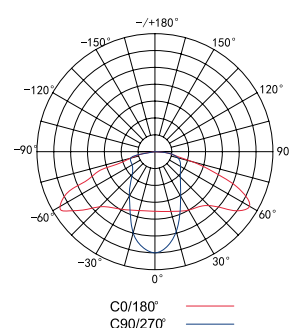

外形尺寸图 Dimension Diagram

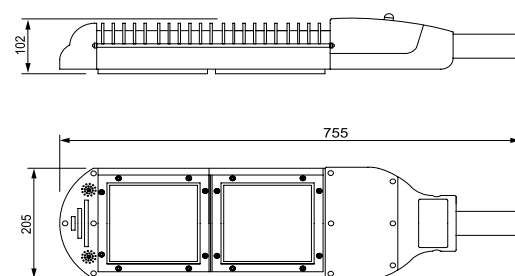

包装参数 Packaging Parameters

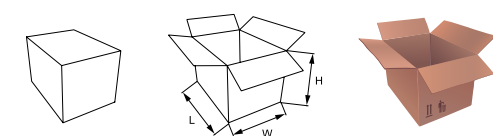

Item	Size(mm)	包装数量 Qty	外箱尺寸 Carton Size
BSD-LD012		1PC	850L×310W×200H



大功率 LED 路灯

High-power LED Street Light

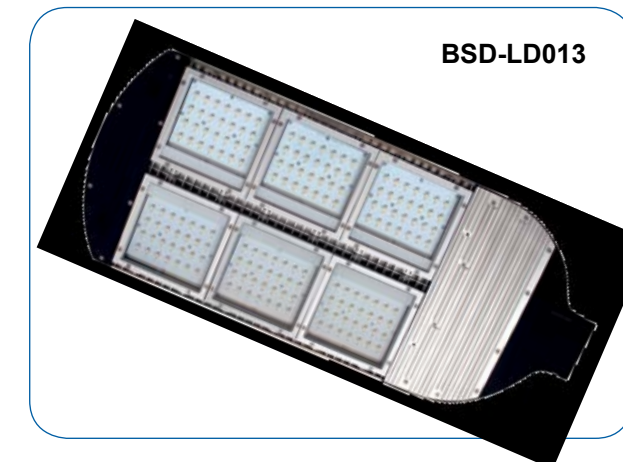

BSD-LD013

产品特点 Product Features

灯具的灯体及灯盖采用铝合金或铝合金压铸材料；透光体采用超白钢化玻璃，具有高强度、透光率好等特点；每颗LED配置独立二次光学系统，取光效率高达93%以上，产品体积小，重量轻，稳固性高，有效降低风阻，减轻灯杆的负荷，有利于抗风，安全可靠；充分体现“人性化”；整灯采用组合式设计。

Lamp body and cover adopt aluminum alloy or aluminum alloy die casting materials; Transmission body adopts ultrawhite toughened glass with features of high strength, excellent light transmission, etc. Each LED configured with independent secondary optical system, light extraction rate is over 93%; Small size, light weight, high stability, effectively reduce wind resistance and burden of lamp-post, it is helpful to wind resistance, safe and reliable; Fully demonstrate humanization; The lamp adopted with combined design.

应用场合 Applications

适用于城市道路、居住区、工业道路、人行道、公园、学校、别墅、庭院等道路照明。

Apply to arterial street, residential area, industrial park, sidewalk, square, park, school, villa area, yards, etc.

规格参数 Specifications

材料 Material	Al
防护等级 IP Rating	IP65
功率 Power (W)	168W
输入电压 Input Voltage (V)	85-265
光源类型 Light source Type	high power LED
芯片尺寸 Chip Size (mil)	45
光源数量 Light Source Quantity (pcs)	168
光源光效 Luminous Efficiency (Lm/W)	90-130
显色指数 CRI	80
色温 Color Temp (k)	2800-7000
环境温度 Environment Temperature (°C)	-40~45
使用寿命 Lifespan (h)	30000-80000

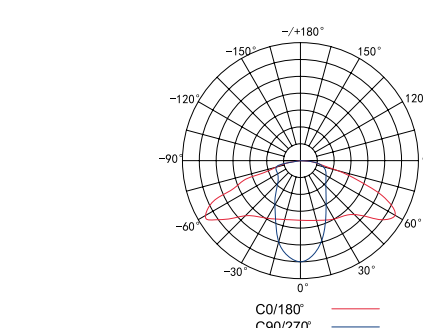

外形尺寸图 Dimension Diagram

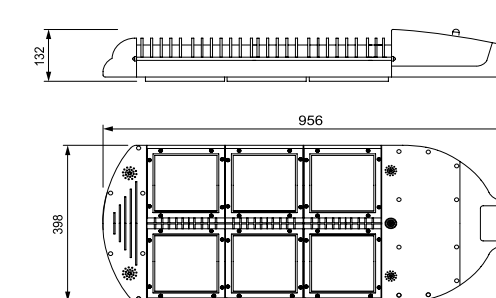

包装参数 Packaging Parameters

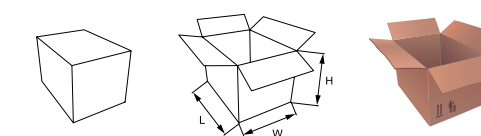

Item	Size(mm)	包装数量 Qty	外箱尺寸 Carton Size
BSD-LD013		1PC	1050L×500W×340H



大功率 LED 路灯

High-power LED Street Light

BSD-LD014



产品特点 Product Features

灯具的灯体及灯盖采用铝合金或铝合金压铸材料；透光体采用超白钢化玻璃，具有高强度、透光率好等特点；每颗LED配置独立二次光学系统，取光效率高达93%以上，产品体积小，重量轻，稳固性高，有效降低风阻，减轻灯杆的负荷，有利于抗风，安全可靠；充分体现“人性化”；整灯采用组合式设计。

Lamp body and cover adopt aluminum alloy or aluminum alloy die casting materials; Transmission body adopts ultrawhite toughened glass with features of high strength, excellent light transmission, etc. Each LED configured with independent secondary optical system, light extraction rate is over 93%; Small size, light weight, high stability, effectively reduce wind resistance and burden of lamp-post, it is helpful to wind resistance, safe and reliable; Fully demonstrate humanization; The lamp adopted with combined design.

应用场合 Applications

适用于城市道路、居住区、工业道路、人行道、公园、学校、别墅、庭院等道路照明。

Apply to arterial street, residential area, industrial park, sidewalk, square, park, school, villa area, yards, etc.

规格参数 Specifications

材 料 Material	Al
防护等级 IP Rating	IP65
功 率 Power (W)	120W
输入电压 Input Voltage (V)	85-265
光源类型 Light source Type	high power LED
芯片尺寸 Chip Size (mil)	45
光源数量 Light Source Quantity (pcs)	48
光源光效 Luminous Efficiency (Lm/W)	90-130
显色指数 CRI	80
色 温 Color Temp (k)	2800-7000
环境温度 Environment Temperature (°C)	-40~45
使用寿命 Lifespan (h)	30000-80000



配光曲线 Light Distribution Curve

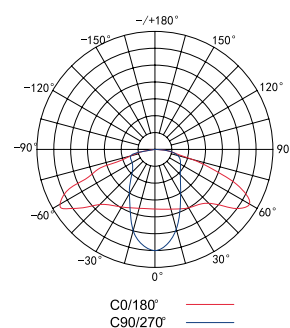

外形尺寸图 Dimension Diagram

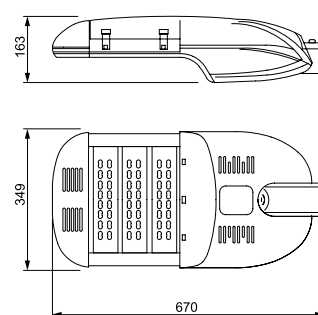

包装参数 Packaging Parameters

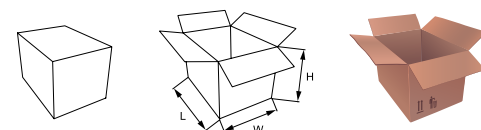

Item	Size(mm)	包装数量 Qty	外箱尺寸 Carton Size
BSD-LD014		1PC	765L×445W×280H



产品特点 Product Features

灯具的灯体及灯盖采用铝合金或铝合金压铸材料；透光体采用超白钢化玻璃，具有高强度、透光率好等特点；每颗LED配置独立二次光学系统，取光效率高达93%以上，产品体积小，重量轻，稳固性高，有效降低风阻，减轻灯杆的负荷，有利于抗风，安全可靠；充分体现“人性化”；整灯采用组合式设计。

Lamp body and cover adopt aluminum alloy or aluminum alloy die casting materials; Transmission body adopts ultrawhite toughened glass with features of high strength, excellent light transmission, etc. Each LED configured with independent secondary optical system, light extraction rate is over 93%; Small size, light weight, high stability, effectively reduce wind resistance and burden of lamp-post, it is helpful to wind resistance, safe and reliable; Fully demonstrate humanization; The lamp adopted with combined design.

应用场合 Applications

适用于城市道路、居住区、工业道路、人行道、公园、学校、别墅、庭院等道路照明。

Apply to arterial street, residential area, industrial park, sidewalk, square, park, school, villa area, yards, etc.

规格参数 Specifications

材 料 Material	Al
防护等级 IP Rating	IP65
功 率 Power (W)	150W
输入电压 Input Voltage (V)	85-265
光源类型 Light source Type	high power LED
芯片尺寸 Chip Size (mil)	45
光源数量 Light Source Quantity (pcs)	64
光源光效 Luminous Efficiency (Lm/W)	90-130
显色指数 CRI	80
色 温 Color Temp (k)	2800-7000
环境温度 Environment Temperature (°C)	-40~45
使用寿命 Lifespan (h)	30000-80000

大功率 LED 路灯

High-power LED Street Light



BSD-LD015



配光曲线 Light Distribution Curve

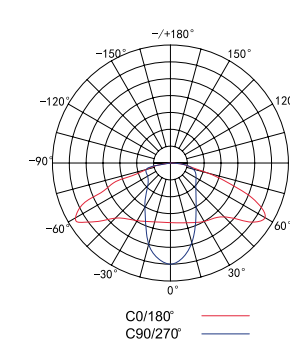

外形尺寸图 Dimension Diagram

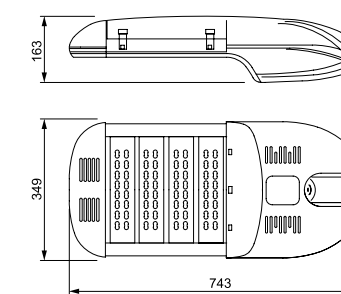

包装参数 Packaging Parameters

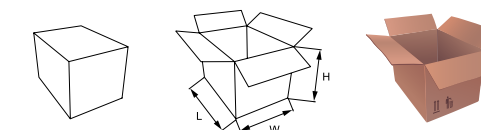

Item	Size(mm)	包装数量 Qty	外箱尺寸 Carton Size
BSD-LD015		1PC	915L×445W×280H



大功率 LED 路灯

High-power LED Street Light

BSD-LD016



产品特点 Product Features

灯具的灯体及灯盖采用铝合金或铝合金压铸材料；透光体采用超白钢化玻璃，具有高强度、透光率好等特点；每颗LED配置独立二次光学系统，取光效率高达93%以上，产品体积小，重量轻，稳固性高，有效降低风阻，减轻灯杆的负荷，有利于抗风，安全可靠；充分体现“人性化”；整灯采用组合式设计。

Lamp body and cover adopt aluminum alloy or aluminum alloy die casting materials; Transmission body adopts ultrawhite toughened glass with features of high strength, excellent light transmission, etc. Each LED configured with independent secondary optical system, light extraction rate is over 93%; Small size, light weight, high stability, effectively reduce wind resistance and burden of lamp-post, it is helpful to wind resistance, safe and reliable; Fully demonstrate humanization; The lamp adopted with combined design.

应用场合 Applications

适用于城市道路、居住区、工业道路、人行道、公园、学校、别墅、庭院等道路照明。

Apply to arterial street, residential area, industrial park, sidewalk, square, park, school, villa area, yards, etc.

规格参数 Specifications

材料 Material	Al
防护等级 IP Rating	IP65
功率 Power (W)	200W
输入电压 Input Voltage (V)	85-265
光源类型 Light source Type	high power LED
芯片尺寸 Chip Size (mil)	45
光源数量 Light Source Quantity (pcs)	80
光源光效 Luminous Efficiency (Lm/W)	90-130
显色指数 CRI	80
色温 Color Temp (k)	2800-7000
环境温度 Environment Temperature (°C)	-40~45
使用寿命 Lifespan (h)	30000-80000



配光曲线 Light Distribution Curve

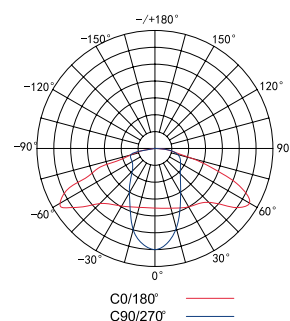

外形尺寸图 Dimension Diagram

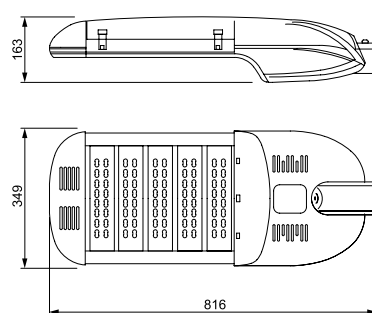

包装参数 Packaging Parameters

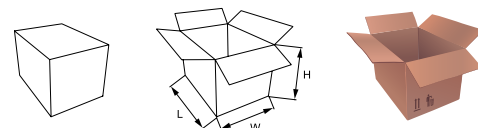

Item	Size(mm)	包装数量 Qty	外箱尺寸 Carton Size
BSD-LD016		1PC	985L×445W×280H



大功率 LED 路灯

High-power LED Street Light

BSD-LD017



产品特点 Product Features

光衰小，灯具采用高电压低电流驱动和间歇式工作的自主专利技术，有效解决了LED灯芯发热问题，经实测可连续工作16000小时光衰不超过百分之五。寿命长，电源采用的电子元器件寿命均在10万小时以上。节能效率高，无需AC/DC转换，直接用220V驱动，比高压钠灯节电百分之七十左右。

Low luminous decay, adopt with high voltage and low current driving and batch-type working independent patent technology, effectively solved LED chip heating problem. Continuously working for 16,000 hours, luminous decay is less than 5%. Long lifespan, the average life of power supply's electronic part is more than 100,000 hours. High energy saving efficiency, using 220V driving directly rather than transferring AC/DC. Saving energy around 70% comparing with HPSL.

应用场合 Applications

适用于城市道路、居住区、工业道路、人行道、公园、学校、别墅、庭院等道路照明。

Apply to arterial street, residential area, industrial park, sidewalk, square, park, school, villa area, yards, etc.

规格参数 Specifications

材料 Material	Al
防护等级 IP Rating	IP65
功率 Power (W)	50W
输入电压 Input Voltage (V)	220
光源类型 Light source Type	Integrated LED
芯片尺寸 Chip Size (mil)	45
光源数量 Light Source Quantity (pcs)	1
光源光效 Luminous Efficiency (Lm/W)	90-130
显色指数 CRI	80
色温 Color Temp (k)	2800-7000
环境温度 Environment Temperature (°C)	-40~45
使用寿命 Lifespan (h)	30000-80000

配光曲线 Light Distribution Curve

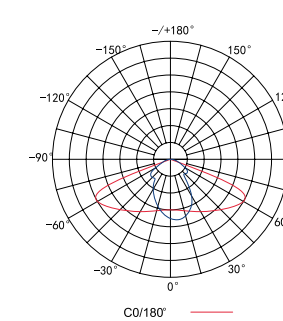

外形尺寸图 Dimension Diagram

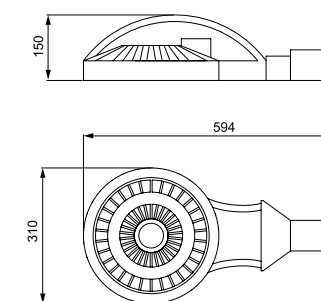

包装参数 Packaging Parameters

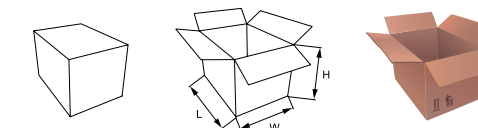

Item	Size(mm)	包装数量 Qty	外箱尺寸 Carton Size
BSD-LD017		1PC	650L×380W×200H



大功率 LED 路灯

High-power LED Street Light

BSD-LD018

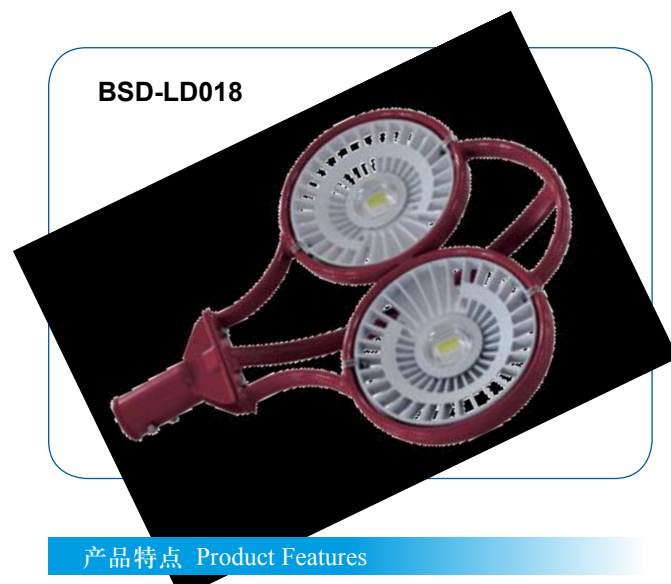

产品特点 Product Features

光衰小，灯具采用高电压低电流驱动和间歇式工作的自主专利技术，有效解决了LED灯芯发热问题，经实测可连续工作16000小时光衰不超过百分之五。寿命长，电源采用的电子元器件寿命均在10万小时以上。节能效率高，无需AC/DC转换，直接用220V驱动，比高压钠灯节电百分之七十左右。

Low luminous decay, adopt with high voltage and low current driving and batch-type working independent patent technology, effectively solved LED chip heating problem. Continuously working for 16,000 hours, luminous decay is less than 5%. Long lifespan, the average life of power supply's electronic part is more than 100,000 hours. High energy saving efficiency, using 220V driving directly rather than transferring AC/DC. Saving energy around 70% comparing with HPSL.

应用场合 Applications

适用于城市道路、居住区、工业道路、人行道、公园、学校、别墅、庭院等道路照明。

Apply to arterial street, residential area, industrial park, sidewalk, square, park, school, villa area, yards, etc.

规格参数 Specifications

材料 Material	Al
防护等级 IP Rating	IP65
功率 Power (W)	100W
输入电压 Input Voltage (V)	220
光源类型 Light source Type	Integrated LED
芯片尺寸 Chip Size (mil)	45
光源数量 Light Source Quantity (pcs)	2
光源光效 Luminous Efficiency (Lm/W)	90-130
显色指数 CRI	80
色温 Color Temp (k)	2800-7000
环境温度 Environment Temperature (°C)	-40~45
使用寿命 Lifespan (h)	30000-80000



配光曲线 Light Distribution Curve

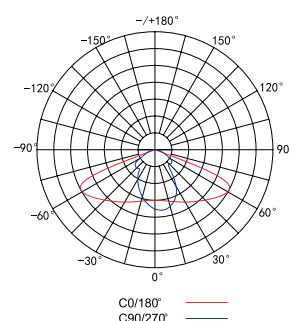

外形尺寸图 Dimension Diagram

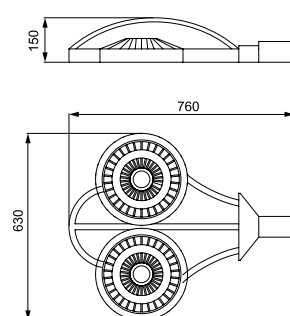

包装参数 Packaging Parameters

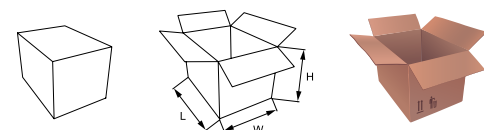

Item	Size(mm)	包装数量 Qty	外箱尺寸 Carton Size
BSD-LD018		1PC	820L×680W×200H



大功率 LED 路灯

High-power LED Street Light

BSD-LD019



产品特点 Product Features

光衰小，灯具采用高电压低电流驱动和间歇式工作的自主专利技术，有效解决了LED灯芯发热问题，经实测可连续工作16000小时光衰不超过百分之五。寿命长，电源采用的电子元器件寿命均在10万小时以上。节能效率高，无需AC/DC转换，直接用220V驱动，比高压钠灯节电百分之七十左右。

Low luminous decay, adopt with high voltage and low current driving and batch-type working independent patent technology, effectively solved LED chip heating problem. Continuously working for 16,000 hours, luminous decay is less than 5%. Long lifespan, the average life of power supply's electronic part is more than 100,000 hours. High energy saving efficiency, using 220V driving directly rather than transferring AC/DC. Saving energy around 70% comparing with HPSL.

应用场合 Applications

适用于城市道路、居住区、工业道路、人行道、公园、学校、别墅、庭院等道路照明。

Apply to arterial street, residential area, industrial park, sidewalk, square, park, school, villa area, yards, etc.

规格参数 Specifications

材料 Material	Al
防护等级 IP Rating	IP65
功率 Power (W)	150W
输入电压 Input Voltage (V)	220
光源类型 Light source Type	Integrated LED
芯片尺寸 Chip Size (mil)	45
光源数量 Light Source Quantity (pcs)	3
光源光效 Luminous Efficiency (Lm/W)	90-130
显色指数 CRI	80
色温 Color Temp (k)	2800-7000
环境温度 Environment Temperature (°C)	-40~45
使用寿命 Lifespan (h)	30000-80000

配光曲线 Light Distribution Curve

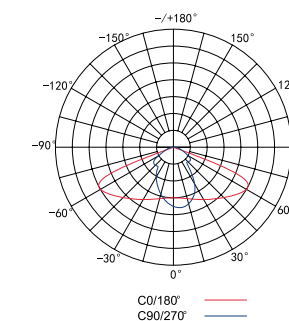

外形尺寸图 Dimension Diagram

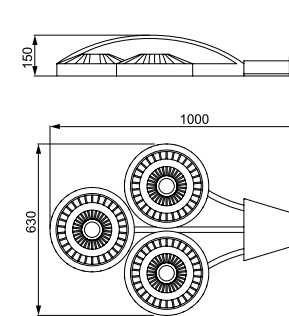

包装参数 Packaging Parameters

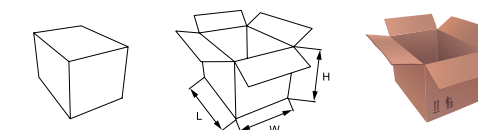

Item	Size(mm)	包装数量 Qty	外箱尺寸 Carton Size
BSD-LD019		1PC	1035L×680W×200H



大功率 LED 路灯

High-power LED Street Light

BSD-LD020



产品特点 Product Features

光衰小，灯具采用高电压低电流驱动和间歇式工作的自主专利技术，有效解决了LED灯芯发热问题，经实测可连续工作16000小时光衰不超过百分之五。寿命长，电源采用的电子元器件寿命均在10万小时以上。节能效率高，无需AC/DC转换，直接用220V驱动，比高压钠灯节电百分之七十左右。

Low luminous decay, adopt with high voltage and low current driving and batch-type working independent patent technology, effectively solved LED chip heating problem. Continuously working for 16,000 hours, luminous decay is less than 5%. Long lifespan, the average life of power supply's electronic part is more than 100,000 hours. High energy saving efficiency, using 220V driving directly rather than transferring AC/DC. Saving energy around 70% comparing with HPSL.

应用场合 Applications

适用于城市道路、居住区、工业道路、人行道、公园、学校、别墅、庭院等道路照明。

Apply to arterial street, residential area, industrial park, sidewalk, square, park, school, villa area, yards, etc.

规格参数 Specifications

材料 Material	Al
防护等级 IP Rating	IP65
功率 Power (W)	200W
输入电压 Input Voltage (V)	220
光源类型 Light source Type	Integrated LED
芯片尺寸 Chip Size (mil)	45
光源数量 Light Source Quantity (pcs)	4
光源光效 Luminous Efficiency (Lm/W)	90-130
显色指数 CRI	80
色温 Color Temp (k)	2800-7000
环境温度 Environment Temperature (°C)	-40~45
使用寿命 Lifespan (h)	30000-80000

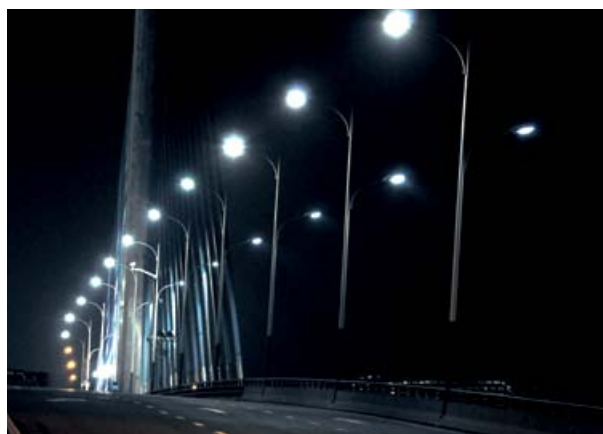

配光曲线 Light Distribution Curve

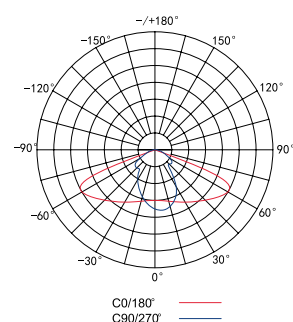

外形尺寸图 Dimension Diagram

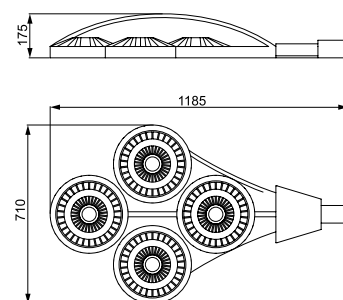

包装参数 Packaging Parameters

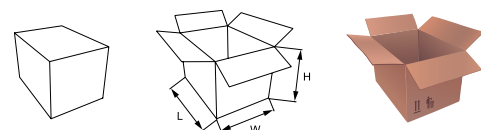

Item	Size(mm)	包装数量 Qty	外箱尺寸 Carton Size
BSD-LD020		1PC	1210L×750W×220H



大功率 LED 路灯

High-power LED Street Light

BSD-LD021



产品特点 Product Features

灯具的灯体及灯盖采用铝合金或铝合金压铸材料；透光体采用超白钢化玻璃，具有高强度、透光率好等特点；每颗LED配置独立二次光学系统，取光效率高达93%以上，产品体积小，重量轻，稳固性高，有效降低风阻，减轻灯杆的负荷，有利于抗风，安全可靠；充分体现“人性化”；整灯采用组合式设计。

Lamp body and cover adopt aluminum alloy or aluminum alloy die casting materials; Transmission body adopts ultrawhite toughened glass with features of high strength, excellent light transmission, etc. Each LED configured with independent secondary optical system, light extraction rate is over 93%; Small size, light weight, high stability, effectively reduce wind resistance and burden of lamp-post, it is helpful to wind resistance, safe and reliable; Fully demonstrate humanization; The lamp adopted with combined design.

应用场合 Applications

适用于城市道路、居住区、工业道路、人行道、公园、学校、别墅、庭院等道路照明。

Apply to arterial street, residential area, industrial park, sidewalk, square, park, school, villa area, yards, etc.

规格参数 Specifications

材料 Material	Al
防护等级 IP Rating	IP65
功率 Power (W)	180W
输入电压 Input Voltage (V)	85-265
光源类型 Light source Type	high power LED
芯片尺寸 Chip Size (mil)	45
光源数量 Light Source Quantity (pcs)	180
光源光效 Luminous Efficiency (Lm/W)	90-130
显色指数 CRI	80
色温 Color Temp (k)	2800-7000
环境温度 Environment Temperature (°C)	-40~45
使用寿命 Lifespan (h)	30000-80000

配光曲线 Light Distribution Curve

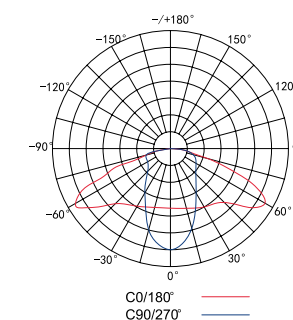

外形尺寸图 Dimension Diagram

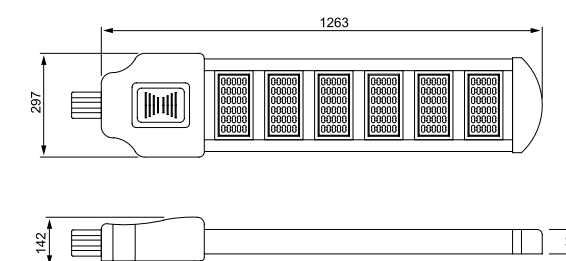

包装参数 Packaging Parameters

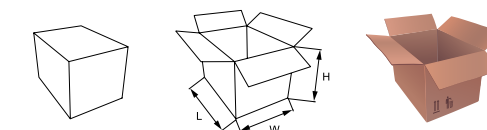

Item	Size(mm)	包装数量 Qty	外箱尺寸 Carton Size
BSD-LD021		1PC	1380L×350W×200H



大功率 LED 路灯

High-power LED Street Light

BSD-LD022



产品特点 Product Features

灯具的灯体及灯盖采用铝合金或铝合金压铸材料；透光体采用超白钢化玻璃，具有高强度、透光率好等特点；每颗LED配置独立二次光学系统，取光效率高达93%以上，产品体积小，重量轻，稳固性高，有效降低风阻，减轻灯杆的负荷，有利于抗风，安全可靠；充分体现“人性化”；整灯采用组合式设计。

Lamp body and cover adopt aluminum alloy or aluminum alloy die casting materials; Transmission body adopts ultrawhite toughened glass with features of high strength, excellent light transmission, etc. Each LED configured with independent secondary optical system, light extraction rate is over 93%; Small size, light weight, high stability, effectively reduce wind resistance and burden of lamp-post, it is helpful to wind resistance, safe and reliable; Fully demonstrate humanization; The lamp adopted with combined design.

应用场合 Applications

适用于城市道路、居住区、工业道路、人行道、公园、学校、别墅、庭院等道路照明。

Apply to arterial street, residential area, industrial park, sidewalk, square, park, school, villa area, yards, etc.

规格参数 Specifications

材料 Material	Al
防护等级 IP Rating	IP65
功率 Power (W)	60W
输入电压 Input Voltage (V)	85-265
光源类型 Light source Type	high power LED
芯片尺寸 Chip Size (mil)	45
光源数量 Light Source Quantity (pcs)	48
光源光效 Luminous Efficiency (Lm/W)	90-130
显色指数 CRI	80
色温 Color Temp (k)	2800-7000
环境温度 Environment Temperature (°C)	-40~45
使用寿命 Lifespan (h)	30000-80000



配光曲线 Light Distribution Curve

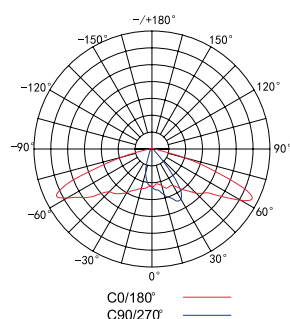

外形尺寸图 Dimension Diagram

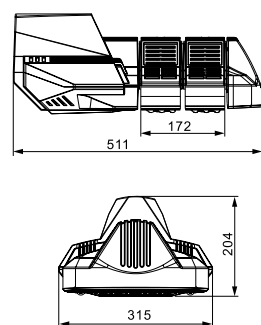

包装参数 Packaging Parameters

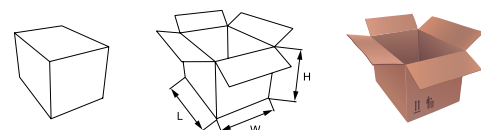

Item	Size(mm)	包装数量 Qty	外箱尺寸 Carton Size
BSD-LD022		1PC	600L×400W×300H



产品特点 Product Features

灯具的灯体及灯盖采用铝合金或铝合金压铸材料；透光体采用超白钢化玻璃，具有高强度、透光率好等特点；每颗LED配置独立二次光学系统，取光效率高达93%以上，产品体积小，重量轻，稳固性高，有效降低风阻，减轻灯杆的负荷，有利于抗风，安全可靠；充分体现“人性化”；整灯采用组合式设计。

Lamp body and cover adopt aluminum alloy or aluminum alloy die casting materials; Transmission body adopts ultrawhite toughened glass with features of high strength, excellent light transmission, etc. Each LED configured with independent secondary optical system, light extraction rate is over 93%; Small size, light weight, high stability, effectively reduce wind resistance and burden of lamp-post, it is helpful to wind resistance, safe and reliable; Fully demonstrate humanization; The lamp adopted with combined design.

应用场合 Applications

适用于城市道路、居住区、工业道路、人行道、公园、学校、别墅、庭院等道路照明。

Apply to arterial street, residential area, industrial park, sidewalk, square, park, school, villa area, yards, etc.

规格参数 Specifications

材料 Material	Al
防护等级 IP Rating	IP65
功率 Power (W)	90W
输入电压 Input Voltage (V)	85-265
光源类型 Light source Type	high power LED
芯片尺寸 Chip Size (mil)	45
光源数量 Light Source Quantity (pcs)	72
光源光效 Luminous Efficiency (Lm/W)	90-130
显色指数 CRI	80
色温 Color Temp (k)	2800-7000
环境温度 Environment Temperature (°C)	-40~45
使用寿命 Lifespan (h)	30000-80000

大功率 LED 路灯

High-power LED Street Light



BSD-LD023



配光曲线 Light Distribution Curve

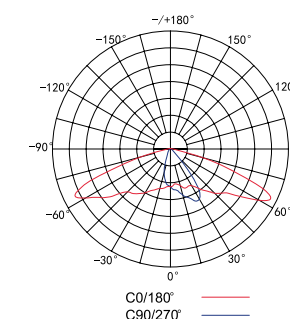

外形尺寸图 Dimension Diagram

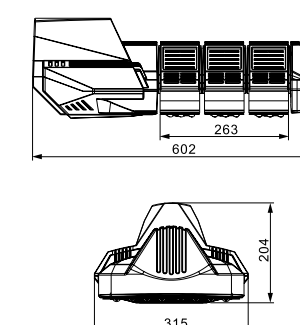

包装参数 Packaging Parameters

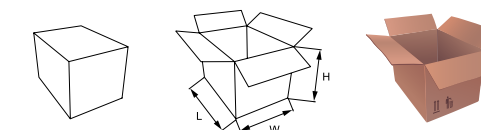

Item	Size(mm)	包装数量 Qty	外箱尺寸 Carton Size
BSD-LD023		1PC	700L×400W×300H



大功率 LED 路灯

High-power LED Street Light

BSD-LD024



产品特点 Product Features

灯具的灯体及灯盖采用铝合金或铝合金压铸材料；透光体采用超白钢化玻璃，具有高强度、透光率好等特点；每颗LED配置独立二次光学系统，取光效率高达93%以上，产品体积小，重量轻，稳固性高，有效降低风阻，减轻灯杆的负荷，有利于抗风，安全可靠；充分体现“人性化”；整灯采用组合式设计。

Lamp body and cover adopt aluminum alloy or aluminum alloy die casting materials; Transmission body adopts ultrawhite toughened glass with features of high strength, excellent light transmission, etc. Each LED configured with independent secondary optical system, light extraction rate is over 93%; Small size, light weight, high stability, effectively reduce wind resistance and burden of lamp-post, it is helpful to wind resistance, safe and reliable; Fully demonstrate humanization; The lamp adopted with combined design.

应用场合 Applications

适用于城市道路、居住区、工业道路、人行道、公园、学校、别墅、庭院等道路照明。

Apply to arterial street, residential area, industrial park, sidewalk, square, park, school, villa area, yards, etc.

规格参数 Specifications

材料 Material	Al
防护等级 IP Rating	IP65
功率 Power (W)	120W
输入电压 Input Voltage (V)	85-265
光源类型 Light source Type	high power LED
芯片尺寸 Chip Size (mil)	45
光源数量 Light Source Quantity (pcs)	96
光源光效 Luminous Efficiency (Lm/W)	90-130
显色指数 CRI	80
色温 Color Temp (k)	2800-7000
环境温度 Environment Temperature (°C)	-40~45
使用寿命 Lifespan (h)	30000-80000



配光曲线 Light Distribution Curve

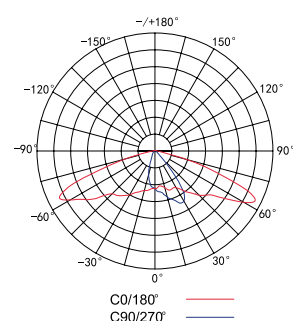

外形尺寸图 Dimension Diagram

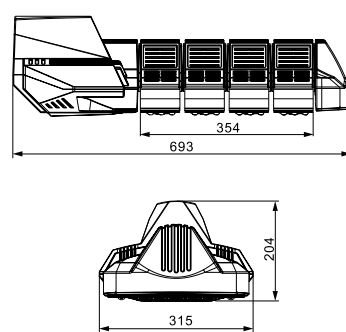

包装参数 Packaging Parameters

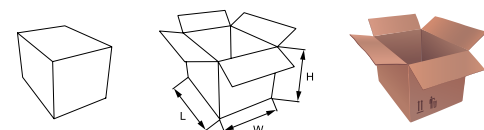

Item	Size(mm)	包装数量 Qty	外箱尺寸 Carton Size
BSD-LD024		1PC	780L×400W×300H



产品特点 Product Features

灯具的灯体及灯盖采用铝合金或铝合金压铸材料；透光体采用超白钢化玻璃，具有高强度、透光率好等特点；每颗LED配置独立二次光学系统，取光效率高达93%以上，产品体积小，重量轻，稳固性高，有效降低风阻，减轻灯杆的负荷，有利于抗风，安全可靠；充分体现“人性化”；整灯采用组合式设计。

Lamp body and cover adopt aluminum alloy or aluminum alloy die casting materials; Transmission body adopts ultrawhite toughened glass with features of high strength, excellent light transmission, etc. Each LED configured with independent secondary optical system, light extraction rate is over 93%; Small size, light weight, high stability, effectively reduce wind resistance and burden of lamp-post, it is helpful to wind resistance, safe and reliable; Fully demonstrate humanization; The lamp adopted with combined design.

应用场合 Applications

适用于城市道路、居住区、工业道路、人行道、公园、学校、别墅、庭院等道路照明。

Apply to arterial street, residential area, industrial park, sidewalk, square, park, school, villa area, yards, etc.

规格参数 Specifications

材料 Material	Al
防护等级 IP Rating	IP65
功率 Power (W)	150W
输入电压 Input Voltage (V)	85-265
光源类型 Light source Type	high power LED
芯片尺寸 Chip Size (mil)	45
光源数量 Light Source Quantity (pcs)	120
光源光效 Luminous Efficiency (Lm/W)	90-130
显色指数 CRI	80
色温 Color Temp (k)	2800-7000
环境温度 Environment Temperature (°C)	-40~45
使用寿命 Lifespan (h)	30000-80000

大功率 LED 路灯

High-power LED Street Light



BSD-LD025



配光曲线 Light Distribution Curve

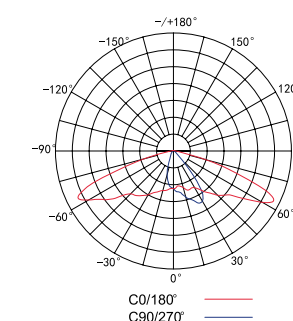

外形尺寸图 Dimension Diagram

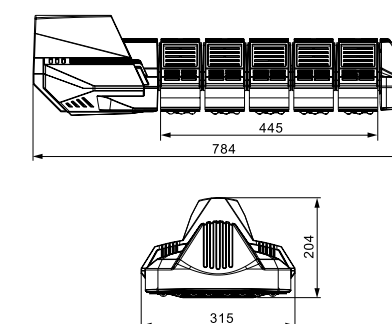

包装参数 Packaging Parameters

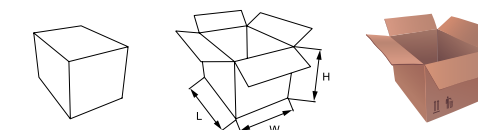

Item	Size(mm)	包装数量 Qty	外箱尺寸 Carton Size
BSD-LD025		1PC	865L×400W×300H



大功率 LED 路灯

High-power LED Street Light

BSD-LD026



产品特点 Product Features

灯具的灯体及灯盖采用铝合金或铝合金压铸材料；透光体采用超白钢化玻璃，具有高强度、透光率好等特点；每颗LED配置独立二次光学系统，取光效率高达93%以上，产品体积小，重量轻，稳固性高，有效降低风阻，减轻灯杆的负荷，有利于抗风，安全可靠；充分体现“人性化”；整灯采用组合式设计。

Lamp body and cover adopt aluminum alloy or aluminum alloy die casting materials; Transmission body adopts ultrawhite toughened glass with features of high strength, excellent light transmission, etc. Each LED configured with independent secondary optical system, light extraction rate is over 93%; Small size, light weight, high stability, effectively reduce wind resistance and burden of lamp-post, it is helpful to wind resistance, safe and reliable; Fully demonstrate humanization; The lamp adopted with combined design.

应用场合 Applications

适用于城市道路、居住区、工业道路、人行道、公园、学校、别墅、庭院等道路照明。

Apply to arterial street, residential area, industrial park, sidewalk, square, park, school, villa area, yards, etc.

规格参数 Specifications

材料 Material	Al
防护等级 IP Rating	IP65
功率 Power (W)	190W
输入电压 Input Voltage (V)	85-265
光源类型 Light source Type	high power LED
芯片尺寸 Chip Size (mil)	45
光源数量 Light Source Quantity (pcs)	144
光源光效 Luminous Efficiency (Lm/W)	90-130
显色指数 CRI	80
色温 Color Temp (k)	2800-7000
环境温度 Environment Temperature (°C)	-40~45
使用寿命 Lifespan (h)	30000-80000

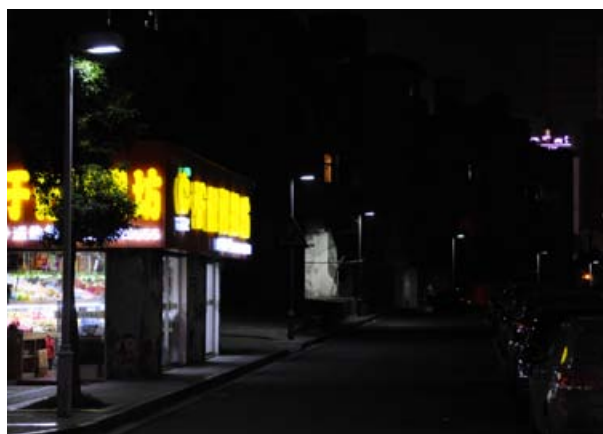

配光曲线 Light Distribution Curve

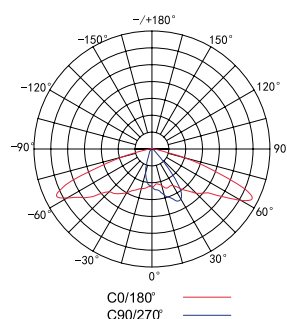

外形尺寸图 Dimension Diagram

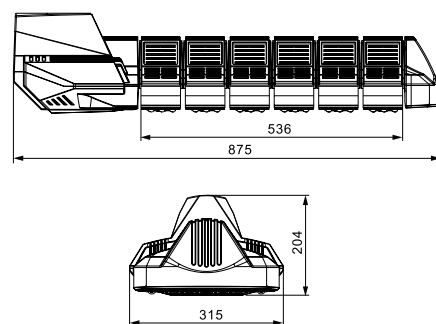

包装参数 Packaging Parameters

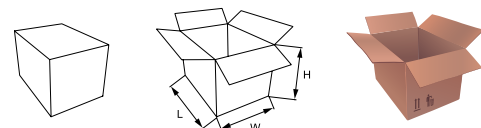

Item	Size(mm)	包装数量 Qty	外箱尺寸 Carton Size
BSD-LD026		1PC	955L×400W×300H



产品特点 Product Features

灯具的灯体及灯盖采用铝合金或铝合金压铸材料；透光体采用超白钢化玻璃，具有高强度、透光率好等特点；每颗LED配置独立二次光学系统，取光效率高达93%以上，产品体积小，重量轻，稳固性高，有效降低风阻，减轻灯杆的负荷，有利于抗风，安全可靠；充分体现“人性化”；整灯采用组合式设计。

Lamp body and cover adopt aluminum alloy or aluminum alloy die casting materials; Transmission body adopts ultrawhite toughened glass with features of high strength, excellent light transmission, etc. Each LED configured with independent secondary optical system, light extraction rate is over 93%; Small size, light weight, high stability, effectively reduce wind resistance and burden of lamp-post, it is helpful to wind resistance, safe and reliable; Fully demonstrate humanization; The lamp adopted with combined design.

应用场合 Applications

适用于城市道路、居住区、工业道路、人行道、公园、学校、别墅、庭院等道路照明。

Apply to arterial street, residential area, industrial park, sidewalk, square, park, school, villa area, yards, etc.

规格参数 Specifications

材料 Material	Al
防护等级 IP Rating	IP65
功率 Power (W)	220W
输入电压 Input Voltage (V)	85-265
光源类型 Light source Type	high power LED
芯片尺寸 Chip Size (mil)	45
光源数量 Light Source Quantity (pcs)	168
光源光效 Luminous Efficiency (Lm/W)	90-130
显色指数 CRI	80
色温 Color Temp (k)	2800-7000
环境温度 Environment Temperature (°C)	-40~45
使用寿命 Lifespan (h)	30000-80000

大功率 LED 路灯

High-power LED Street Light



BSD-LD027



产品特点 Product Features

灯具的灯体及灯盖采用铝合金或铝合金压铸材料；透光体采用超白钢化玻璃，具有高强度、透光率好等特点；每颗LED配置独立二次光学系统，取光效率高达93%以上，产品体积小，重量轻，稳固性高，有效降低风阻，减轻灯杆的负荷，有利于抗风，安全可靠；充分体现“人性化”；整灯采用组合式设计。

Lamp body and cover adopt aluminum alloy or aluminum alloy die casting materials; Transmission body adopts ultrawhite toughened glass with features of high strength, excellent light transmission, etc. Each LED configured with independent secondary optical system, light extraction rate is over 93%; Small size, light weight, high stability, effectively reduce wind resistance and burden of lamp-post, it is helpful to wind resistance, safe and reliable; Fully demonstrate humanization; The lamp adopted with combined design.

应用场合 Applications

适用于城市道路、居住区、工业道路、人行道、公园、学校、别墅、庭院等道路照明。

Apply to arterial street, residential area, industrial park, sidewalk, square, park, school, villa area, yards, etc.

规格参数 Specifications

材料 Material	Al
防护等级 IP Rating	IP65
功率 Power (W)	220W
输入电压 Input Voltage (V)	85-265
光源类型 Light source Type	high power LED
芯片尺寸 Chip Size (mil)	45
光源数量 Light Source Quantity (pcs)	168
光源光效 Luminous Efficiency (Lm/W)	90-130
显色指数 CRI	80
色温 Color Temp (k)	2800-7000
环境温度 Environment Temperature (°C)	-40~45
使用寿命 Lifespan (h)	30000-80000

应用场合 Applications

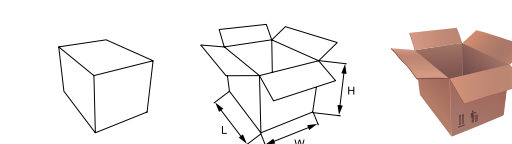

Item	Size(mm)	包装数量 Qty	外箱尺寸 Carton Size
BSD-LD027		1PC	1050L×400W×300H