

# 大功率 LED 隧道灯

## High-power LED Tunnel Light

**BSD-SD012**

### 产品特点 Product Features

大功率LED芯片，使用寿命长；光衰小，5万小时内光衰小于15%。矩形光斑、偏心椭圆形光斑，出光效率高；无眩光，无光污染，均匀度高，达0.7以上。使用高导热、多组分的重量轻、散热快铜镁铝合金高效散热结构，防尘防沙，造型美观，使用方便安全，适用范围广。

Using high power LED chips, long lifespan. Low luminous decay, which is lower than 15% within 50,000 hours. Rectangular and eccentric elliptic light spot make high optical efficiency. No flicker, no light pollution, high uniformity more than 0.7. Using the multicomponent elektron heat dissipation structure with high thermal conductivity, low weight and fast heat dissipation. Dust and sand proof, excellent outlook, convenient and safe, wide applicability.

### 应用场合 Applications

隧道，地下通道，铁路，地下停车场等需要户内照明的场所。

Apply to tunnels, underpasses, railways, underground parkings and other indoor lighting places.

### 规格参数 Specifications

材 料 Material	Al
防护等级 IP Rating	IP65
功 率 Power (W)	120W
输入电压 Input Voltage (V)	85-265
光源类型 Light source Type	Integrated LED
芯片尺寸 Chip Size (mil)	45
光源数量 Light Source Quantity (pcs )	3
光源光效 Luminous Efficiency (Lm/W)	90-130
显色指数 CRI	70-80
色 温 Color Temp (k)	2800-7000
环境温度 Environment Temperature (°C)	-40~45
使用寿命 Lifespan (h)	30000-80000



### 配光曲线 Light Distribution Curve

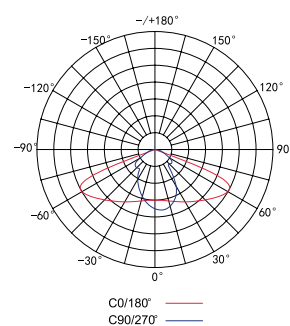

### 外形尺寸图 Dimension Diagram

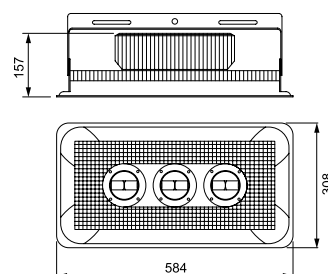

### 包装参数 Packaging Parameters

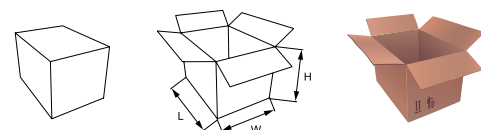

Item	Size(mm)	包装数量 Qty	外箱尺寸 Carton Size
BSD-SD013		1PC	660L×325W×205H

# 大功率 LED 隧道灯

## High-power LED Tunnel Light

**BSD-SD014**

### 产品特点 Product Features

优质铝材壳体，一次压铸成型处理，散热性能优良。AC85V-265V宽电压电源设计，适用全球绝大多数国家和地区，保证灯光稳定性。节能，不含汞，无紫外线污染。

Using high-quality aluminum shell with one-time die-casting molding process which has excellent thermal conductivity. AC85V-265V wide voltage driver design, it is suitable for most countries and areas, and ensure the stability of light. Energy saving, no mercury and ultraviolet light pollution.

### 应用场合 Applications

隧道，地下通道，铁路，地下停车场等需要户内照明的场所。

Apply to tunnels, underpasses, railways, underground parkings and other indoor lighting places.

### 规格参数 Specifications

材 料 Material	Al
防护等级 IP Rating	IP65
功 率 Power (W)	60W
输入电压 Input Voltage (V)	85-265
光源类型 Light source Type	Integrated LED
芯片尺寸 Chip Size (mil)	45
光源数量 Light Source Quantity (pcs )	6
光源光效 Luminous Efficiency (Lm/W)	90-130
显色指数 CRI	70-80
色 温 Color Temp (k)	2800-7000
环境温度 Environment Temperature (°C)	-40~45
使用寿命 Lifespan (h)	30000-80000

### 配光曲线 Light Distribution Curve

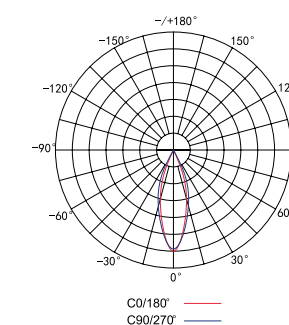

### 外形尺寸图 Dimension Diagram

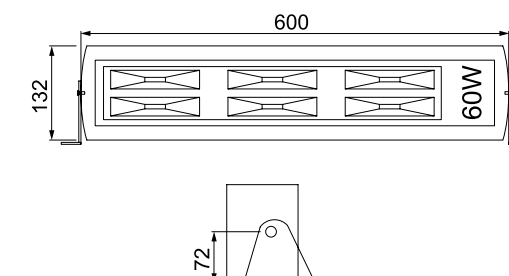

### 包装参数 Packaging Parameters

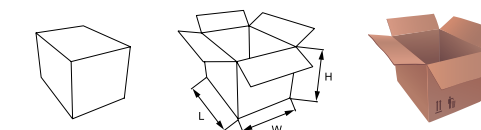

Item	Size(mm)	包装数量 Qty	外箱尺寸 Carton Size
BSD-SD014		6PCS	650L×310W×270H

## 大功率 LED 庭院灯

High-power LED Garden Light



### 产品特点 Product Features

铝合金压铸灯体；高纯铝拉伸反光器，经阳极氧化处理；高品质硅橡胶密封圈，防尘性能好；可安装10-30W LED光源；防护等级IP65；防触电保护等级：I类。

Die-cast aluminum shell; High pure aluminium tensile reflector, anodic oxidation process; High-quality silicon rubber seal ring, good dustproof performance; Can be installed 10-30W LED light source; IP65; Shockproof protection level: I.

### 配光曲线 Light Distribution Curve

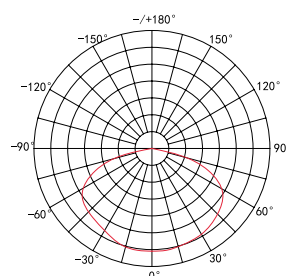

### 应用场合 Applications

适用于城市广场、公园、小区、景观道、步行街、人行道路灯。

Apply to city squares, parks, residential areas, landscape areas, pedestrian streets, walkways, etc.

### 规格参数 Specifications

材料 Material	Al
防护等级 IP Rating	IP65
功率 Power (W)	2*30W
输入电压 Input Voltage (V)	220 ± 20%
光源类型 Light source Type	Integrated LED
芯片尺寸 Chip Size (mil)	45
光源数量 Light Source Quantity (pcs)	1
光源光效 Luminous Efficiency (Lm/W)	90-130
显色指数 CRI	80
色温 Color Temp (k)	2800-7000
环境温度 Environment Temperature (°C)	-40~45
使用寿命 Lifespan (h)	30000-80000

### 外形尺寸图 Dimension Diagram

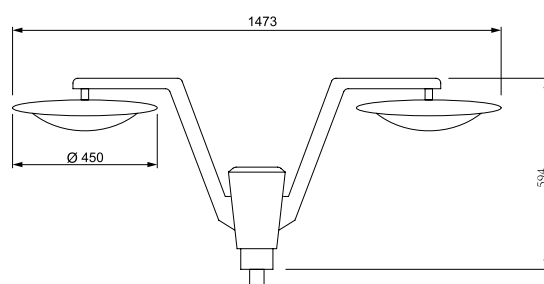

### 包装参数 Packaging Parameters

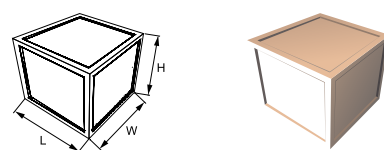

Item	Size(mm)	包装数量 Qty	外箱尺寸 Carton Size
BSD-TY001		1PC	1600L*750W*600H

## 大功率 LED 庭院灯

High-power LED Garden Light



### 产品特点 Product Features

铝合金压铸灯体；高纯铝拉伸反光器，经阳极氧化处理；高品质硅橡胶密封圈，防尘性能好；可安装10-30W LED光源；防护等级IP65；防触电保护等级：I类。

Die-cast aluminum shell; High pure aluminium tensile reflector, anodic oxidation process; High-quality silicon rubber seal ring, good dustproof performance; Can be installed 10-30W LED light source; IP65; Shockproof protection level: I.

### 配光曲线 Light Distribution Curve

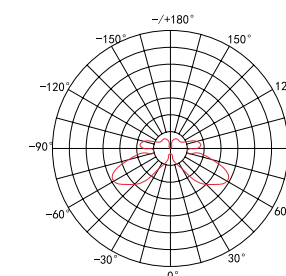

### 应用场合 Applications

适用于城市广场、公园、小区、景观道、步行街、人行道路灯。

Apply to city squares, parks, residential areas, landscape areas, pedestrian streets, walkways, etc.

### 规格参数 Specifications

材料 Material	Al
防护等级 IP Rating	IP65
功率 Power (W)	30W
输入电压 Input Voltage (V)	220 ± 20%
光源类型 Light source Type	Integrated LED
芯片尺寸 Chip Size (mil)	45
光源数量 Light Source Quantity (pcs)	1
光源光效 Luminous Efficiency (Lm/W)	90-130
显色指数 CRI	80
色温 Color Temp (k)	2800-7000
环境温度 Environment Temperature (°C)	-40~45
使用寿命 Lifespan (h)	30000-80000

### 外形尺寸图 Dimension Diagram

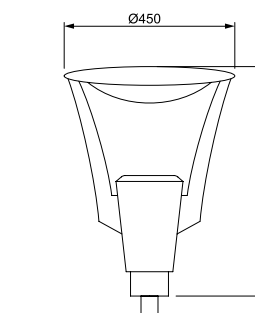

### 包装参数 Packaging Parameters

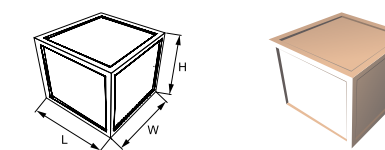

Item	Size(mm)	包装数量 Qty	外箱尺寸 Carton Size
BSD-TY002		1PC	800L*600W*600H



## 大功率 LED 庭院灯

High-power LED Garden Light

**BSD-TY003**

### 产品特点 Product Features

铝合金压铸灯体；高纯铝拉伸反光器，经阳极氧化处理；高品质硅橡胶密封圈，防尘性能好；可安装10-30W LED光源；防护等级IP65；防触电保护等级：I类。

Die-cast aluminum shell; High pure aluminium tensile reflector, anodic oxidation process; High-quality silicon rubber seal ring, good dustproof performance; Can be installed 10-30W LED light source; IP65; Shockproof protection level: I.

### 应用场合 Applications

适用于城市广场、公园、小区、景观道、步行街、人行道路灯。

Apply to city squares, parks, residential areas, landscape areas, pedestrian streets, walkways, etc.

### 规格参数 Specifications

材 料 Material	Al
防护等级 IP Rating	IP65
功 率 Power (W)	30W
输入电压 Input Voltage (V)	220 ± 20%
光源类型 Light source Type	Integrated LED
芯片尺寸 Chip Size (mil)	45
光源数量 Light Source Quantity (pcs )	1
光源光效 Luminous Efficiency (Lm/W)	90-130
显色指数 CRI	80
色 温 Color Temp (k)	2800-7000
环境温度 Environment Temperature (°C)	-40~45
使用寿命 Lifespan (h)	30000-80000



### 配光曲线 Light Distribution Curve

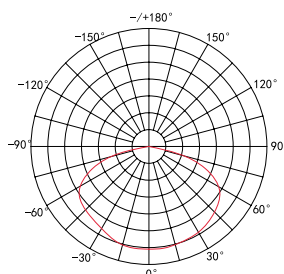

### 外形尺寸图 Dimension Diagram

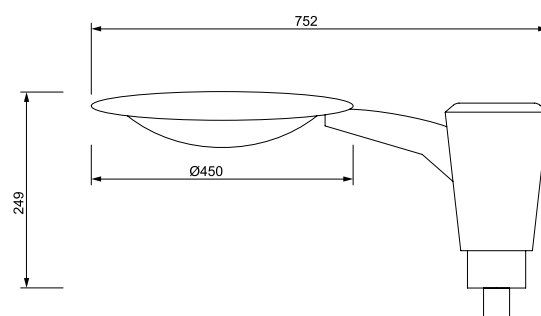

### 包装参数 Packaging Parameters

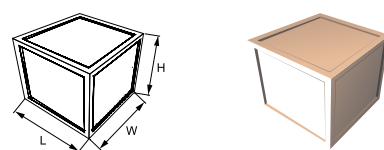

Item	Size(mm)	包装数量 Qty	外箱尺寸 Carton Size
BSD-TY003		1PC	800L×300W×500H

## 大功率 LED 庭院灯

High-power LED Garden Light

**BSD-TY004**

### 产品特点 Product Features

铝合金压铸灯体；高纯铝拉伸反光器，经阳极氧化处理；高品质硅橡胶密封圈，防尘性能好；可安装10-30W LED光源；防护等级IP65；防触电保护等级：I类。

Die-cast aluminum shell; High pure aluminium tensile reflector, anodic oxidation process; High-quality silicon rubber seal ring, good dustproof performance; Can be installed 10-30W LED light source; IP65; Shockproof protection level: I.

### 应用场合 Applications

适用于城市广场、公园、小区、景观道、步行街、人行道路灯。

Apply to city squares, parks, residential areas, landscape areas, pedestrian streets, walkways, etc.

### 规格参数 Specifications

材 料 Material	Al
防护等级 IP Rating	IP65
功 率 Power (W)	30W
输入电压 Input Voltage (V)	220 ± 20%
光源类型 Light source Type	Integrated LED
芯片尺寸 Chip Size (mil)	45
光源数量 Light Source Quantity (pcs )	1
光源光效 Luminous Efficiency (Lm/W)	90-130
显色指数 CRI	80
色 温 Color Temp (k)	2800-7000
环境温度 Environment Temperature (°C)	-40~45
使用寿命 Lifespan (h)	30000-80000

### 配光曲线 Light Distribution Curve

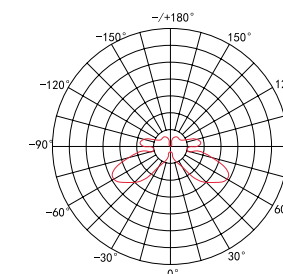

### 外形尺寸图 Dimension Diagram

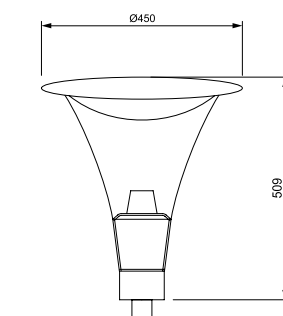

### 包装参数 Packaging Parameters

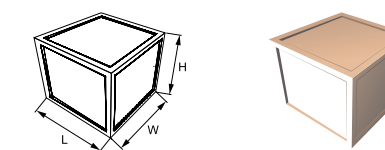

Item	Size(mm)	包装数量 Qty	外箱尺寸 Carton Size
BSD-TY004		1PC	550L×550W×650H

## 大功率 LED 庭院灯

High-power LED Garden Light



### 产品特点 Product Features

铝合金压铸灯体；高纯铝拉伸反光器，经阳极氧化处理；高品质硅橡胶密封圈，防尘性能好；可安装10-30W LED光源；防护等级IP65；防触电保护等级：I类。

Die-cast aluminum shell; High pure aluminium tensile reflector, anodic oxidation process; High-quality silicon rubber seal ring, good dustproof performance; Can be installed 10-30W LED light source; IP65; Shockproof protection level: I.

### 配光曲线 Light Distribution Curve

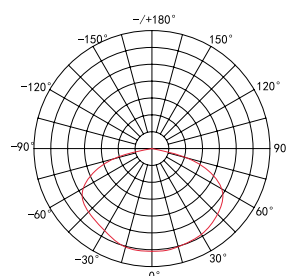

### 应用场合 Applications

适用于城市广场、公园、小区、景观道、步行街、人行道路灯。

Apply to city squares, parks, residential areas, landscape areas, pedestrian streets, walkways, etc.

### 规格参数 Specifications

材料 Material	Al
防护等级 IP Rating	IP65
功率 Power (W)	2*30W
输入电压 Input Voltage (V)	220 ± 20%
光源类型 Light source Type	Integrated LED
芯片尺寸 Chip Size (mil)	45
光源数量 Light Source Quantity (pcs)	2*1
光源光效 Luminous Efficiency (Lm/W)	90-130
显色指数 CRI	80
色温 Color Temp (k)	2800-7000
环境温度 Environment Temperature (°C)	-40~45
使用寿命 Lifespan (h)	30000-80000

### 外形尺寸图 Dimension Diagram

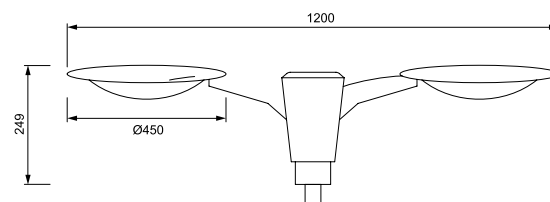

### 包装参数 Packaging Parameters

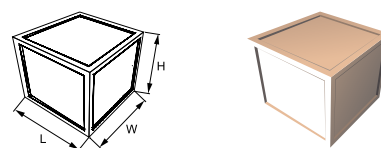

Item	Size(mm)	包装数量 Qty	外箱尺寸 Carton Size
BSD-TY005		1PC	1320L*370W*570H

### 产品特点 Product Features

工作电流低，安全电压工作，热量低；钢化玻璃抗震，不会破损；不含铅，汞等有害物质，对环境没有污染；无辐射；LED灯的寿命长达5万小时；由于LED灯的超长寿命，几乎零维护成本。

Low working current, safe working voltage, low heat; Toughened glass, anti-seismic, hard to damage; Lead and mercury free, no harm to environment; Radiation-free; LED lifespan can reach 50000 hours; Due to the long lifespan, the maintenance cost is almost zero.

### 应用场合 Applications

适用场所为别墅、高档小区、工业园、广场、公园、新农村改造等。还可以配合组成太阳能和风光互补等灯具。

Apply to villa areas, high-grade residential areas, industrial parks, squares, parks, village reconstruction projects, etc. Can be also matched up with solar light and scenery complementary street lamp.

### 规格参数 Specifications

材料 Material	Al
防护等级 IP Rating	IP65
功率 Power (W)	24W
输入电压 Input Voltage (V)	220 ± 20%
光源类型 Light source Type	high power LED
芯片尺寸 Chip Size (mil)	45
光源数量 Light Source Quantity (pcs)	24
光源光效 Luminous Efficiency (Lm/W)	90-130
显色指数 CRI	80
色温 Color Temp (k)	2800-7000
环境温度 Environment Temperature (°C)	-40~45
使用寿命 Lifespan (h)	30000-80000

## 大功率 LED 庭院灯

High-power LED Garden Light



### 配光曲线 Light Distribution Curve

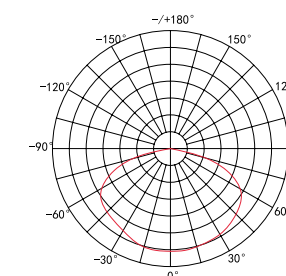

### 外形尺寸图 Dimension Diagram

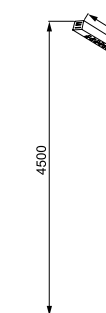

### 包装参数 Packaging Parameters

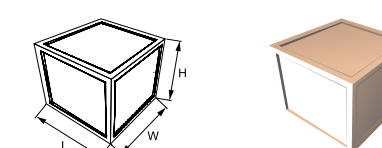

Item	Size(mm)	包装数量 Qty	外箱尺寸 Carton Size
BSD-TY006		1PC	物流木箱包装



## 大功率 LED 庭院灯

High-power LED Garden Light



### 产品特点 Product Features

工作电流低，安全电压工作，热量低；钢化玻璃抗震，不会破损；不含铅，汞等有害物质，对环境没有污染；无辐射；LED灯的寿命长达5万小时；由于LED灯的超长寿命，几乎零维护成本。

Low working current, safe working voltage, low heat; Toughened glass, anti-seismic, hard to damage; Lead and mercury free, no harm to environment; Radiation-free; LED lifespan can reach 50000 hours; Due to the long lifespan, the maintenance cost is almost zero.

### 应用场合 Applications

适用场所为别墅、高档小区、工业园、广场、公园、新农村改造等。还可以配合组成太阳能和风光互补等灯具。

Apply to villa areas, high-grade residential areas, industrial parks, squares, parks, village reconstruction projects, etc. Can be also matched up with solar light and scenery complementary street lamp.

### 规格参数 Specifications

材 料 Material	Al
防护等级 IP Rating	IP65
功 率 Power (W)	24W
输入电压 Input Voltage (V)	220 ± 20%
光源类型 Light source Type	high power LED
芯片尺寸 Chip Size (mil)	45
光源数量 Light Source Quantity (pcs )	24
光源光效 Luminous Efficiency (Lm/W)	90-130
显色指数 CRI	80
色 温 Color Temp (k)	2800-7000
环境温度 Environment Temperature (°C)	-40~45
使用寿命 Lifespan (h)	30000-80000

### 配光曲线 Light Distribution Curve

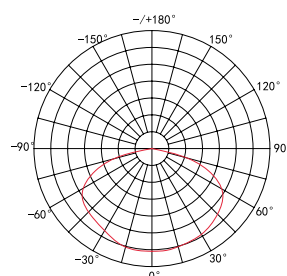

### 外形尺寸图 Dimension Diagram

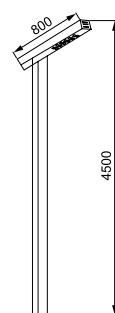

### 包装参数 Packaging Parameters

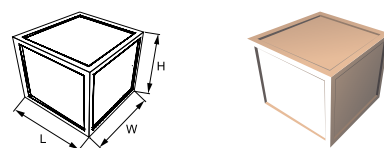

Item	Size(mm)	包装数量 Qty	外箱尺寸 Carton Size
BSD-TY007		1PC	物流木箱包装

## 大功率 LED 庭院灯

High-power LED Garden Light

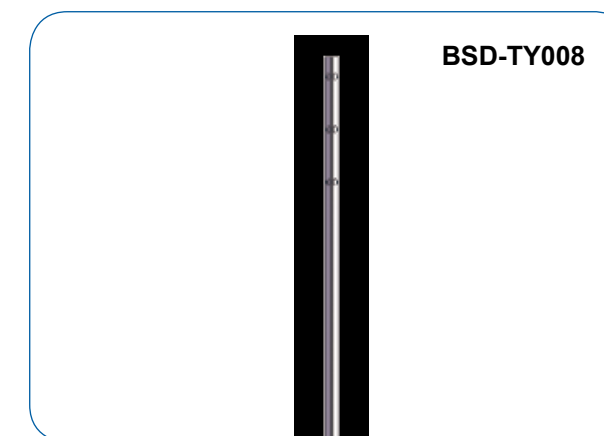

### 产品特点 Product Features

工作电流低，安全电压工作，热量低；钢化玻璃抗震，不会破损；不含铅，汞等有害物质，对环境没有污染；无辐射；LED灯的寿命长达5万小时；由于LED灯的超长寿命，几乎零维护成本。

Low working current, safe working voltage, low heat; Toughened glass, anti-seismic, hard to damage; Lead and mercury free, no harm to environment; Radiation-free; LED lifespan can reach 50000 hours; Due to the long lifespan, the maintenance cost is almost zero.

### 应用场合 Applications

适用场所为别墅、高档小区、工业园、广场、公园、新农村改造等。还可以配合组成太阳能和风光互补等灯具。

Apply to villa areas, high-grade residential areas, industrial parks, squares, parks, village reconstruction projects, etc. Can be also matched up with solar light and scenery complementary street lamp.

### 规格参数 Specifications

材 料 Material	Al
防护等级 IP Rating	IP65
功 率 Power (W)	6W
输入电压 Input Voltage (V)	220 ± 20%
光源类型 Light source Type	high power LED
芯片尺寸 Chip Size (mil)	45
光源数量 Light Source Quantity (pcs )	6
光源光效 Luminous Efficiency (Lm/W)	90-130
显色指数 CRI	80
色 温 Color Temp (k)	2800-7000
环境温度 Environment Temperature (°C)	-40~45
使用寿命 Lifespan (h)	30000-80000

### 配光曲线 Light Distribution Curve

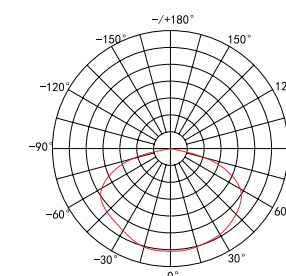

### 外形尺寸图 Dimension Diagram

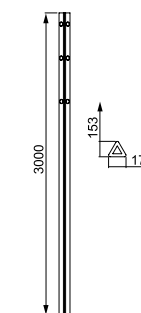

### 包装参数 Packaging Parameters

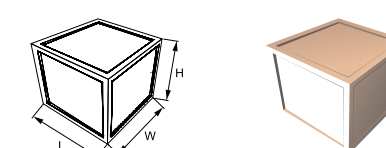

Item	Size(mm)	包装数量 Qty	外箱尺寸 Carton Size
BSD-TY008		5PCS	3100L×250W×250H

# 大功率 LED 草坪灯

## High-power LED Lawn Lamp



# 大功率 LED 草坪灯

## High-power LED Lawn Lamp



### 产品特点 Product Features

采用大功率LED，设计理念领先，优质铝材和高级耐腐材料精工制作，整体性能优良，结构小巧，高效发光，富于色彩与色温变幻，节能效果突出，品牌保证，有很强的性价比优势，适用性强，应用十分广泛。

Using high-power LED, design-leading, precision production with high-quality aluminum & high corrosion-resistant materials. Excellent overall performance, compact structure, high light efficiency. Changeable color and color temperature, outstanding energy-saving effect, having a strong cost performance advantage, brand assurance, strong applicability and widely used.

### 应用场合 Applications

适用于草坪、园艺，小区绿化等景观照明。

Apply to lawns, gardens, residential green projects, landscape lighting, etc.

### 规格参数 Specifications

材 料 Material	Al
防护等级 IP Rating	IP65
功 率 Power (W)	5W
输入电压 Input Voltage (V)	85-265
光源类型 Light source Type	high power LED
芯片尺寸 Chip Size (mil)	45
光源数量 Light Source Quantity (pcs )	1
光源光效 Luminous Efficiency (Lm/W)	90-130
显色指数 CRI	80
色 温 Color Temp (k)	2800-7000
环境温度 Environment Temperature (°C)	-40~45
使用寿命 Lifespan (h)	30000-80000

### 配光曲线 Light Distribution Curve

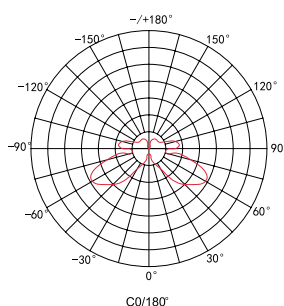

### 外形尺寸图 Dimension Diagram

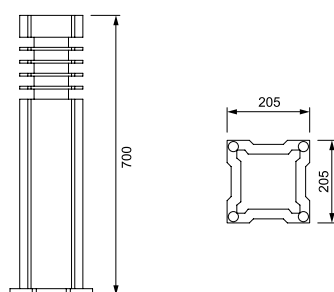

### 包装参数 Packaging Parameters

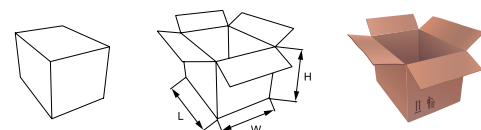

Item	Size(mm)	包装数量 Qty	外箱尺寸 Carton Size
BSD-CP001		1PC	720L×250W×250H

### 产品特点 Product Features

采用大功率LED，设计理念领先，优质铝材和高级耐腐材料精工制作，整体性能优良，结构小巧，高效发光，富于色彩与色温变幻，节能效果突出，品牌保证，有很强的性价比优势，适用性强，应用十分广泛。

Using high-power LED, design-leading, precision production with high-quality aluminum & high corrosion-resistant materials. Excellent overall performance, compact structure, high light efficiency. Changeable color and color temperature, outstanding energy-saving effect, having a strong cost performance advantage, brand assurance, strong applicability and widely used.

### 应用场合 Applications

适用于草坪、园艺，小区绿化等景观照明。

Apply to lawns, gardens, residential green projects, landscape lighting, etc.

### 规格参数 Specifications

材 料 Material	Al
防护等级 IP Rating	IP65
功 率 Power (W)	5W
输入电压 Input Voltage (V)	85-265
光源类型 Light source Type	high power LED
芯片尺寸 Chip Size (mil)	45
光源数量 Light Source Quantity (pcs )	1
光源光效 Luminous Efficiency (Lm/W)	90-130
显色指数 CRI	80
色 温 Color Temp (k)	2800-7000
环境温度 Environment Temperature (°C)	-40~45
使用寿命 Lifespan (h)	30000-80000

### 配光曲线 Light Distribution Curve

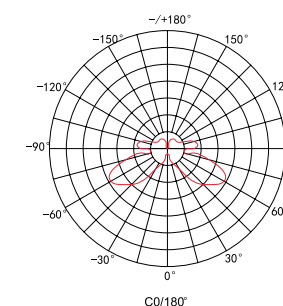

### 外形尺寸图 Dimension Diagram

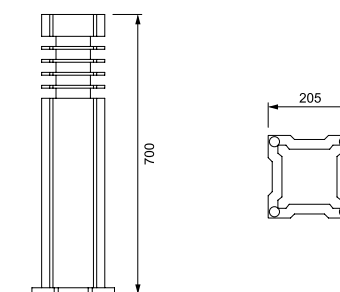

### 包装参数 Packaging Parameters

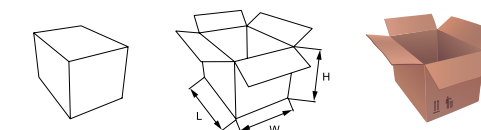

Item	Size(mm)	包装数量 Qty	外箱尺寸 Carton Size
BSD-CP002		1PC	720L×250W×250H



# 大功率 LED 草坪灯

## High-power LED Lawn Lamp



### 产品特点 Product Features

采用大功率LED，设计理念领先，优质铝材和高级耐腐蚀材料精工制作，整体性能优良，结构小巧，高效发光，富于色彩与色温变幻，节能效果突出，品牌保证，有很强的性价比优势，适用性强，应用十分广泛。

Using high-power LED, design-leading, precision production with high-quality aluminum & high corrosion-resistant materials. Excellent overall performance, compact structure, high light efficiency. Changeable color and color temperature, outstanding energy-saving effect, having a strong cost performance advantage, brand assurance, strong applicability and widely used.

### 应用场合 Applications

适用于草坪、园艺，小区绿化等景观照明。

Apply to lawns, gardens, residential green projects, landscape lighting, etc.

### 规格参数 Specifications

材 料 Material	Al
防护等级 IP Rating	IP65
功 率 Power (W)	5W
输入电压 Input Voltage (V)	85-265
光源类型 Light source Type	high power LED
芯片尺寸 Chip Size (mil)	45
光源数量 Light Source Quantity (pcs )	1
光源光效 Luminous Efficiency (Lm/W)	90-130
显色指数 CRI	80
色 温 Color Temp (k)	2800-7000
环境温度 Environment Temperature (°C)	-40~45
使用寿命 Lifespan (h)	30000-80000



### 配光曲线 Light Distribution Curve

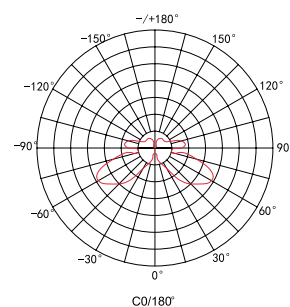

### 外形尺寸图 Dimension Diagram

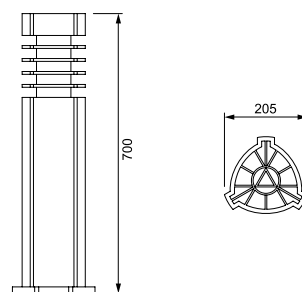

### 包装参数 Packaging Parameters

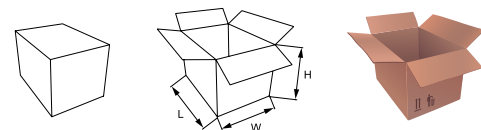

Item	Size(mm)	包装数量 Qty	外箱尺寸 Carton Size
BSD-CP003		1PC	720L×250W×250H

# 大功率 LED 草坪灯

## High-power LED Lawn Lamp



### 产品特点 Product Features

采用大功率LED，设计理念领先，优质铝材和高级耐腐蚀材料精工制作，整体性能优良，结构小巧，高效发光，富于色彩与色温变幻，节能效果突出，品牌保证，有很强的性价比优势，适用性强，应用十分广泛。

Using high-power LED, design-leading, precision production with high-quality aluminum & high corrosion-resistant materials. Excellent overall performance, compact structure, high light efficiency. Changeable color and color temperature, outstanding energy-saving effect, having a strong cost performance advantage, brand assurance, strong applicability and widely used.

### 应用场合 Applications

适用于草坪、园艺，小区绿化等景观照明。

Apply to lawns, gardens, residential green projects, landscape lighting, etc.

### 规格参数 Specifications

材 料 Material	Al
防护等级 IP Rating	IP65
功 率 Power (W)	5W
输入电压 Input Voltage (V)	85-265
光源类型 Light source Type	high power LED
芯片尺寸 Chip Size (mil)	45
光源数量 Light Source Quantity (pcs )	1
光源光效 Luminous Efficiency (Lm/W)	90-130
显色指数 CRI	80
色 温 Color Temp (k)	2800-7000
环境温度 Environment Temperature (°C)	-40~45
使用寿命 Lifespan (h)	30000-80000

### 配光曲线 Light Distribution Curve

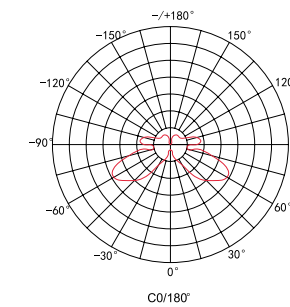

### 外形尺寸图 Dimension Diagram

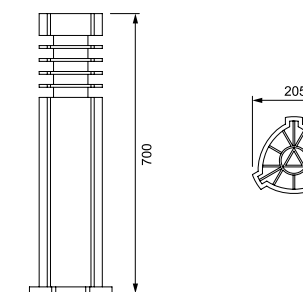

### 包装参数 Packaging Parameters

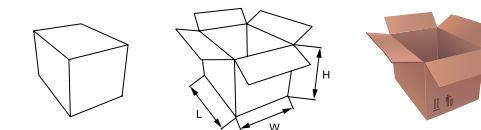

Item	Size(mm)	包装数量 Qty	外箱尺寸 Carton Size
BSD-CP004		1PC	720L×250W×250H

## 大功率 LED 草坪灯

High-power LED Lawn Lamp



### 产品特点 Product Features

采用大功率LED，设计理念领先，优质铝材和高级耐腐材料精工制作，整体性能优良，结构小巧，高效发光，富于色彩与色温变幻，节能效果突出，品牌保证，有很强的性价比优势，适用性强，应用十分广泛。

Using high-power LED, design-leading, precision production with high-quality aluminum & high corrosion-resistant materials. Excellent overall performance, compact structure, high light efficiency. Changeable color and color temperature, outstanding energy-saving effect, having a strong cost performance advantage, brand assurance, strong applicability and widely used.

### 应用场合 Applications

适用于草坪、园艺，小区绿化等景观照明。

Apply to lawns, gardens, residential green projects, landscape lighting, etc.

### 规格参数 Specifications

材 料 Material	Al
防护等级 IP Rating	IP65
功 率 Power (W)	5W
输入电压 Input Voltage (V)	95-240
光源类型 Light source Type	high power LED
芯片尺寸 Chip Size (mil)	45
光源数量 Light Source Quantity (pcs )	1
光源光效 Luminous Efficiency (Lm/W)	90-130
显色指数 CRI	80
色 温 Color Temp (k)	2800-7000
环境温度 Environment Temperature (°C)	-40~45
使用寿命 Lifespan (h)	30000-80000



### 配光曲线 Light Distribution Curve

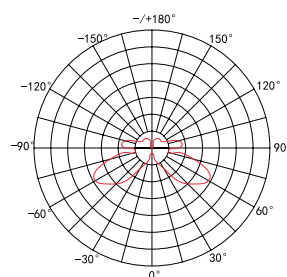

### 外形尺寸图 Dimension Diagram

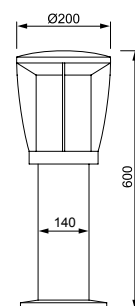

### 包装参数 Packaging Parameters

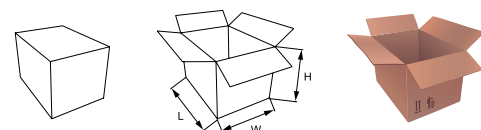

Item	Size(mm)	包装数量 Qty	外箱尺寸 Carton Size
BSD-CP005		1PC	610L×210W×210H

## 大功率 LED 草坪灯

High-power LED Lawn Lamp



### 产品特点 Product Features

采用大功率LED，设计理念领先，优质铝材和高级耐腐材料精工制作，整体性能优良，结构小巧，高效发光，富于色彩与色温变幻，节能效果突出，品牌保证，有很强的性价比优势，适用性强，应用十分广泛。

Using high-power LED, design-leading, precision production with high-quality aluminum & high corrosion-resistant materials. Excellent overall performance, compact structure, high light efficiency. Changeable color and color temperature, outstanding energy-saving effect, having a strong cost performance advantage, brand assurance, strong applicability and widely used.

### 应用场合 Applications

适用于草坪、园艺，小区绿化等景观照明。

Apply to lawns, gardens, residential green projects, landscape lighting, etc.

### 规格参数 Specifications

材 料 Material	Al
防护等级 IP Rating	IP65
功 率 Power (W)	5W
输入电压 Input Voltage (V)	85-265
光源类型 Light source Type	high power LED
芯片尺寸 Chip Size (mil)	45
光源数量 Light Source Quantity (pcs )	1
光源光效 Luminous Efficiency (Lm/W)	90-130
显色指数 CRI	80
色 温 Color Temp (k)	2800-7000
环境温度 Environment Temperature (°C)	-40~45
使用寿命 Lifespan (h)	30000-80000

### 配光曲线 Light Distribution Curve

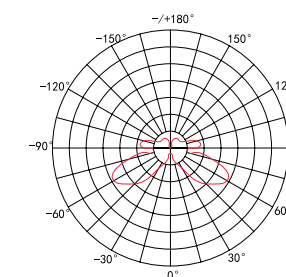

### 外形尺寸图 Dimension Diagram

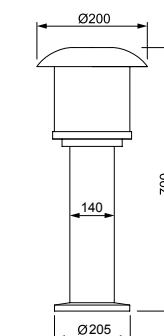

### 包装参数 Packaging Parameters

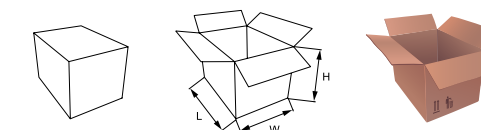

Item	Size(mm)	包装数量 Qty	外箱尺寸 Carton Size
BSD-CP006		1PC	720L×220W×220H



# 大功率 LED 草坪灯

## High-power LED Lawn Lamp

**BSD-CP007**

### 产品特点 Product Features

采用大功率LED, 设计理念领先, 优质铝材和高级耐腐材料精工制作, 整体性能优良, 结构小巧, 高效发光, 富于色彩与色温变幻, 节能效果突出, 品牌保证, 有很强的性价比优势, 适用性强, 应用十分广泛。

Using high-power LED, design-leading, precision production with high-quality aluminum & high corrosion-resistant materials. Excellent overall performance, compact structure, high light efficiency. Changeable color and color temperature, outstanding energy-saving effect, having a strong cost performance advantage, brand assurance, strong applicability and widely used.

### 应用场合 Applications

适用于草坪、园艺, 小区绿化等景观照明。

Apply to lawns, gardens, residential green projects, landscape lighting, etc.

### 规格参数 Specifications

材 料 Material	Al
防护等级 IP Rating	IP65
功 率 Power (W)	5W
输入电压 Input Voltage (V)	85-265
光源类型 Light source Type	high power LED
芯片尺寸 Chip Size (mil)	45
光源数量 Light Source Quantity (pcs )	1
光源光效 Luminous Efficiency (Lm/W)	90-130
显色指数 CRI	80
色 温 Color Temp (k)	2800-7000
环境温度 Environment Temperature (°C)	-40~45
使用寿命 Lifespan (h)	30000-80000

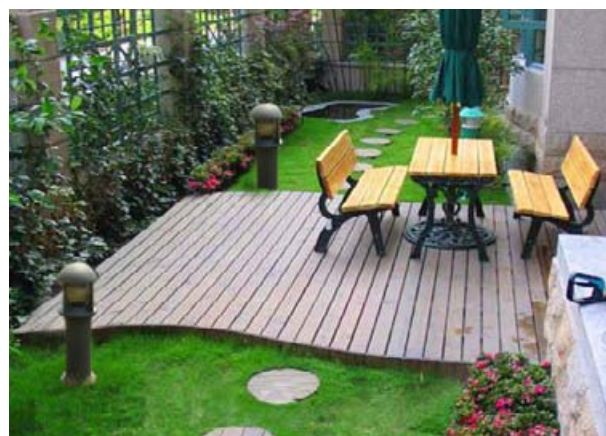

### 配光曲线 Light Distribution Curve

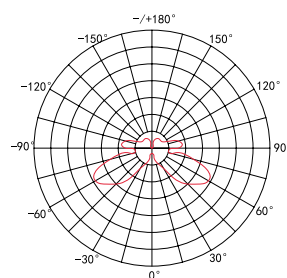

### 外形尺寸图 Dimension Diagram

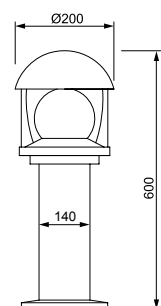

### 包装参数 Packaging Parameters

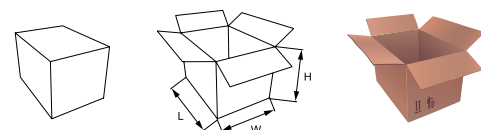

Item	Size(mm)	包装数量 Qty	外箱尺寸 Carton Size
BSD-CP007		1PC	610L×210W×210H

# 大功率 LED 草坪灯

## High-power LED Lawn Lamp

**BSD-CP008**

### 产品特点 Product Features

采用大功率LED, 设计理念领先, 优质铝材和高级耐腐材料精工制作, 整体性能优良, 结构小巧, 高效发光, 富于色彩与色温变幻, 节能效果突出, 品牌保证, 有很强的性价比优势, 适用性强, 应用十分广泛。

Using high-power LED, design-leading, precision production with high-quality aluminum & high corrosion-resistant materials. Excellent overall performance, compact structure, high light efficiency. Changeable color and color temperature, outstanding energy-saving effect, having a strong cost performance advantage, brand assurance, strong applicability and widely used.

### 应用场合 Applications

适用于草坪、园艺, 小区绿化等景观照明。

Apply to lawns, gardens, residential green projects, landscape lighting, etc.

### 规格参数 Specifications

材 料 Material	Al
防护等级 IP Rating	IP65
功 率 Power (W)	5W
输入电压 Input Voltage (V)	85-265
光源类型 Light source Type	high power LED
芯片尺寸 Chip Size (mil)	45
光源数量 Light Source Quantity (pcs )	1
光源光效 Luminous Efficiency (Lm/W)	90-130
显色指数 CRI	80
色 温 Color Temp (k)	2800-7000
环境温度 Environment Temperature (°C)	-40~45
使用寿命 Lifespan (h)	30000-80000

### 配光曲线 Light Distribution Curve

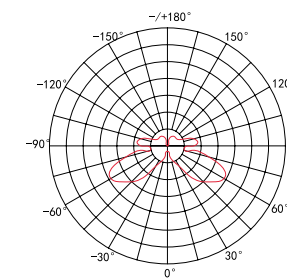

### 外形尺寸图 Dimension Diagram

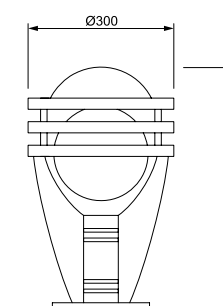

### 包装参数 Packaging Parameters

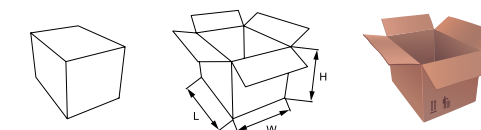

Item	Size(mm)	包装数量 Qty	外箱尺寸 Carton Size
BSD-CP008		1PC	510L×310W×310H

# 大功率 LED 草坪灯

## High-power LED Lawn Lamp



### 产品特点 Product Features

采用大功率LED，设计理念领先，优质铝材和高级耐腐材料精工制作，整体性能优良，结构小巧，高效发光，富于色彩与色温变幻，节能效果突出，品牌保证，有很强的性价比优势，适用性强，应用十分广泛。

Using high-power LED, design-leading, precision production with high-quality aluminum & high corrosion-resistant materials. Excellent overall performance, compact structure, high light efficiency. Changeable color and color temperature, outstanding energy-saving effect, having a strong cost performance advantage, brand assurance, strong applicability and widely used.

### 应用场合 Applications

适用于草坪、园艺，小区绿化等景观照明。

Apply to lawns, gardens, residential green projects, landscape lighting, etc.

### 规格参数 Specifications

材 料 Material	Al
防护等级 IP Rating	IP65
功 率 Power (W)	5W
输入电压 Input Voltage (V)	85-265
光源类型 Light source Type	high power LED
芯片尺寸 Chip Size (mil)	45
光源数量 Light Source Quantity (pcs )	1
光源光效 Luminous Efficiency (Lm/W)	90-130
显色指数 CRI	80
色 温 Color Temp (k)	2800-7000
环境温度 Environment Temperature (°C)	-40~45
使用寿命 Lifespan (h)	30000-80000



### 配光曲线 Light Distribution Curve

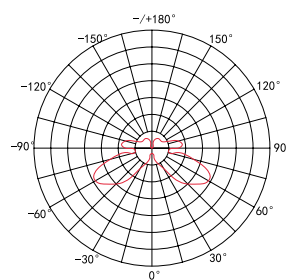

### 外形尺寸图 Dimension Diagram

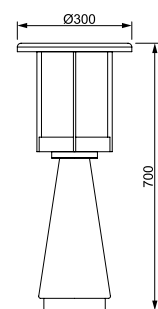

### 包装参数 Packaging Parameters

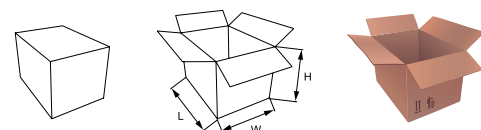

Item	Size(mm)	包装数量 Qty	外箱尺寸 Carton Size
BSD-CP009		1PC	710L×310W×310H

# 大功率 LED 草坪灯

## High-power LED Lawn Lamp



### 产品特点 Product Features

采用大功率LED，设计理念领先，优质铝材和高级耐腐材料精工制作，整体性能优良，结构小巧，高效发光，富于色彩与色温变幻，节能效果突出，品牌保证，有很强的性价比优势，适用性强，应用十分广泛。

Using high-power LED, design-leading, precision production with high-quality aluminum & high corrosion-resistant materials. Excellent overall performance, compact structure, high light efficiency. Changeable color and color temperature, outstanding energy-saving effect, having a strong cost performance advantage, brand assurance, strong applicability and widely used.

### 应用场合 Applications

适用于草坪、园艺，小区绿化等景观照明。

Apply to lawns, gardens, residential green projects, landscape lighting, etc.

### 规格参数 Specifications

材 料 Material	Al
防护等级 IP Rating	IP65
功 率 Power (W)	5W
输入电压 Input Voltage (V)	85-265
光源类型 Light source Type	high power LED
芯片尺寸 Chip Size (mil)	45
光源数量 Light Source Quantity (pcs )	1
光源光效 Luminous Efficiency (Lm/W)	90-130
显色指数 CRI	80
色 温 Color Temp (k)	2800-7000
环境温度 Environment Temperature (°C)	-40~45
使用寿命 Lifespan (h)	30000-80000



### 配光曲线 Light Distribution Curve

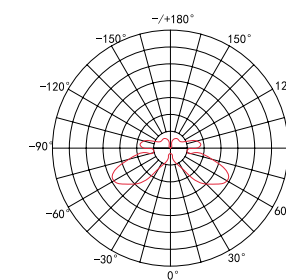

### 外形尺寸图 Dimension Diagram

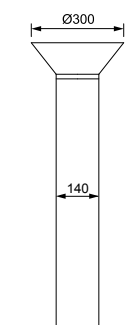

### 包装参数 Packaging Parameters

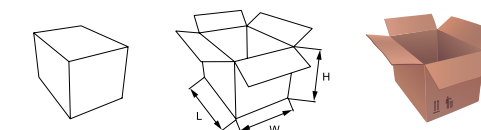

Item	Size(mm)	包装数量 Qty	外箱尺寸 Carton Size
BSD-CP010		1PC	950L×310W×310H