



LED 水下灯

LED Under Water Light



产品特点 Product Features

设计理念领先, 高级耐腐蚀材料精工制作, 整体性能优良, 结构小巧, 高效发光, 富于色彩与色温变幻。

Design-leading, precision production with high corrosion-resistant materials. Excellent overall performance, compact structure, high lighting efficiency. Changeable color and color temperature.

应用场合 Applications

适用于水底、喷泉、营造气氛。

Apply to underwater, fountain and creating atmosphere occasion.

规格参数 Specifications

材 料 Material	不锈钢 Stainless Steel
防护等级 IP Rating	IP68
功 率 Power (W)	15W
输入电压 Input Voltage (V)	12
光源类型 Light source Type	high power LED
芯片尺寸 Chip Size (mil)	45
光源数量 Light Source Quantity (pcs)	15
光源光效 Luminous Efficiency (Lm/W)	90-130
显色指数 CRI	80
色 温 Color Temp (k)	2800-7000
环境温度 Environment Temperature (°C)	-40~45
使用寿命 Lifespan (h)	30000-80000

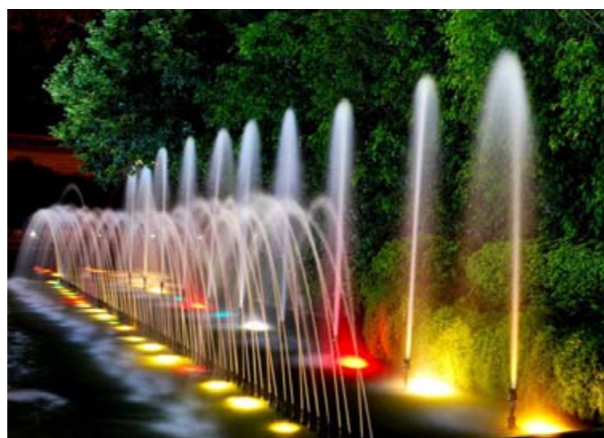

配光曲线 Light Distribution Curve

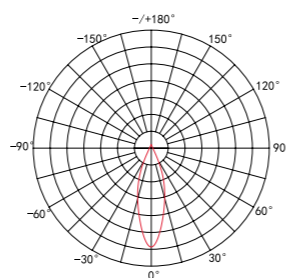

外形尺寸图 Dimension Diagram

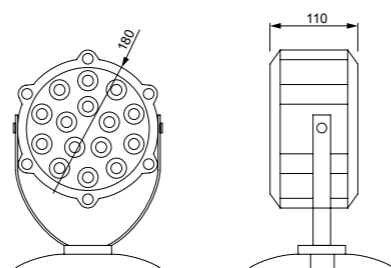

包装参数 Packaging Parameters

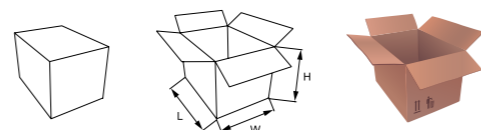

Item	Size(mm)	包装数量 Qty	外箱尺寸 Carton Size
BSD-SX022		12PCS	410L×410W×370H



LED 水下灯

LED Under Water Light



产品特点 Product Features

设计理念领先, 高级耐腐蚀材料精工制作, 整体性能优良, 结构小巧, 高效发光, 富于色彩与色温变幻。

Design-leading, precision production with high corrosion-resistant materials. Excellent overall performance, compact structure, high lighting efficiency. Changeable color and color temperature.

应用场合 Applications

适用于水底、喷泉、营造气氛。

Apply to underwater, fountain and creating atmosphere occasion.

规格参数 Specifications

材 料 Material	Al
防护等级 IP Rating	IP68
功 率 Power (W)	9W
输入电压 Input Voltage (V)	12
光源类型 Light source Type	high power LED
芯片尺寸 Chip Size (mil)	45
光源数量 Light Source Quantity (pcs)	9
光源光效 Luminous Efficiency (Lm/W)	90-130
显色指数 CRI	—
色 温 Color Temp (k)	RGB
环境温度 Environment Temperature (°C)	-40~45
使用寿命 Lifespan (h)	30000-80000

配光曲线 Light Distribution Curve

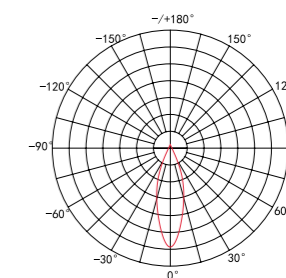

外形尺寸图 Dimension Diagram

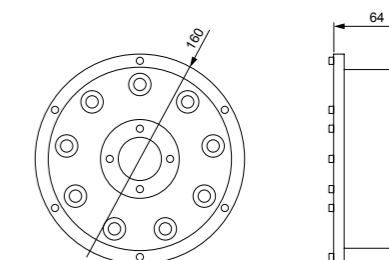

包装参数 Packaging Parameters

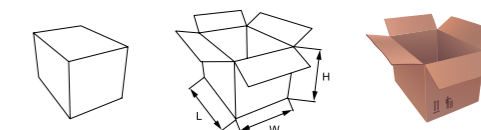

Item	Size(mm)	包装数量 Qty	外箱尺寸 Carton Size
BSD-SX023		20PCS	370L×370W×370H



LED 水下灯

LED Under Water Light

BSD-SX024



产品特点 Product Features

高强度钢化玻璃罩, 为LED定身制作; 增强型硅橡胶密封垫, 防护等级可达IP68. 光源选用超高亮度的LED, 颜色有单色、双色、七彩颜色渐变、跳变等多种色彩组合选择. 具有显著的节能效果, 性能稳定, 寿命长. 造型别致优雅, 防尘、防漏电. 投射角度调节范围大. 健康环保. 无频闪, 无红外光和紫外光.

High strength toughened glass cover, tailor-made for LED; Enhanced silicon rubber sealer, IP68. Using super bright LED lights as the light source; Single, double, rainbow color and colors can be freely combined. Remarkable energy saving effect, stable, long lifespan. Unique and elegant outlook, dust proof and anti-creep. Wide projection angle, healthy and environmental. No flicker, no infrared and UV light.

应用场合 Applications

广泛适用于: 公园绿化、草坪、广场、庭院、花坛、步行街、瀑布、舞台、喷泉水底等装饰照明场所.

Apply to park greening, lawn, square, courtyard, flower terrace, pedestrian street, waterfall, stage, fountain and other decorative lighting places.

规格参数 Specifications

材料 Material	不锈钢 Stainless Steel
防护等级 IP Rating	IP68
功率 Power (W)	5W
输入电压 Input Voltage (V)	12
光源类型 Light source Type	DIP
芯片尺寸 Chip Size (mil)	12*12
光源数量 Light Source Quantity (pcs)	60
光源光效 Luminous Efficiency (Lm/W)	90-130
显色指数 CRI	—
色温 Color Temp (k)	RGB
环境温度 Environment Temperature (°C)	-40~45
使用寿命 Lifespan (h)	30000-80000



配光曲线 Light Distribution Curve

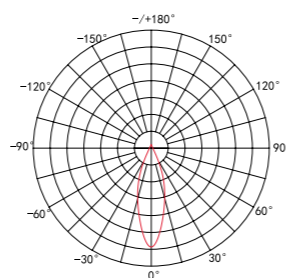

外形尺寸图 Dimension Diagram

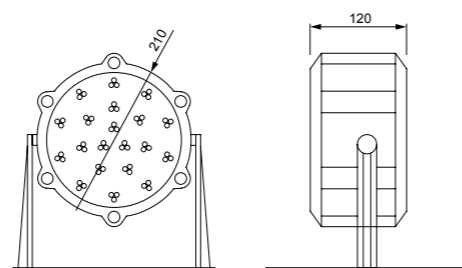

包装参数 Packaging Parameters

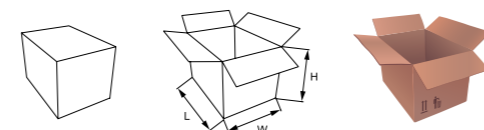

Item	Size(mm)	包装数量 Qty	外箱尺寸 Carton Size
BSD-SX024		8PCS	470L×470W×290H



产品特点 Product Features

灯具电器一体化, 造型轻巧美观, 设计新颖, 安装简单, 可做各种单色, 白, 红, 绿, 黄, 蓝, 紫.

Integrated design of lighting and electrical appliance with the advantages of compact design, easy installation, optional various homochromy-white, red, green, yellow, blue, purple.

应用场合 Applications

适用于建筑物轮廓照明、桥梁、广告牌、商场、服装专卖店等局部照明场所.

Apply to building outline lighting, bridge, billboard, shopping mall, clothing specialty store and other local lighting place.

规格参数 Specifications

材料 Material	Al
防护等级 IP Rating	IP65
功率 Power (W)	3.6W
输入电压 Input Voltage (V)	100-240
光源类型 Light source Type	DIP LED
芯片尺寸 Chip Size (mil)	12*12
光源数量 Light Source Quantity (pcs)	60
光源光效 Luminous Efficiency (Lm/W)	90-130
显色指数 CRI	—
色温 Color Temp (k)	R Y B G W
环境温度 Environment Temperature (°C)	-40~45
使用寿命 Lifespan (h)	30000-80000

大功率 LED 点光源

High-power LED Point Source



BSD-DGY001



安装示意图 Installation Diagram

示例一: 单线出现, 点光源与电源线或电源控制线连接

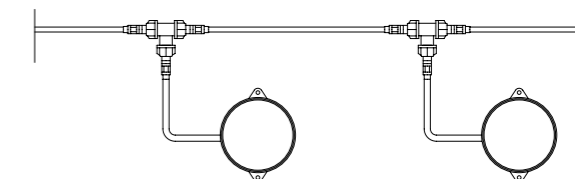

示例二: 点光源之间公母接头对接

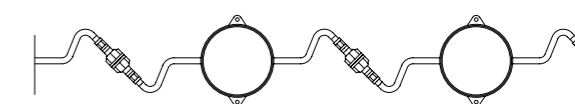

外形尺寸图 Dimension Diagram

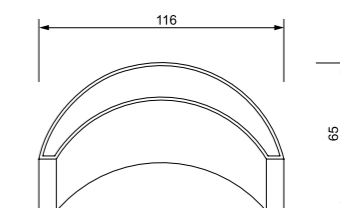

包装参数 Packaging Parameters

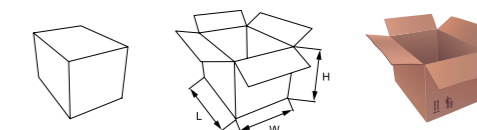

Item	Size(mm)	包装数量 Qty	外箱尺寸 Carton Size
BSD-DGY001		80PCS	620L×500W×370H

大功率 LED 点光源

High-power LED Point Source

BSD-DGY002

产品特点 Product Features

灯具电器一体化, 造型轻巧美观, 设计新颖, 安装简单, 可做各种单色, 白, 红, 绿, 黄, 蓝, 紫。

Integrated design of lighting and electrical appliance with the advantages of compact design, easy installation, optional various homochromy-white, red, green, yellow, blue, purple.

应用场合 Applications

适用于建筑物轮廓照明、桥梁、广告牌、商场、服装专卖店等局部照明场所。

Apply to building outline lighting, bridge, billboard, shopping mall, clothing specialty store and other local lighting place.

规格参数 Specifications

材 料 Material	Al
防护等级 IP Rating	IP65
功 率 Power (W)	2W
输入电压 Input Voltage (V)	100-240
光源类型 Light source Type	DIP LED
芯片尺寸 Chip Size (mil)	12*12
光源数量 Light Source Quantity (pcs)	36
光源光效 Luminous Efficiency (Lm/W)	90-130
显色指数 CRI	80
色 温 Color Temp (k)	红/黄/蓝/绿/白/暖白
环境温度 Environment Temperature (°C)	-40~45
使用寿命 Lifespan (h)	30000-80000

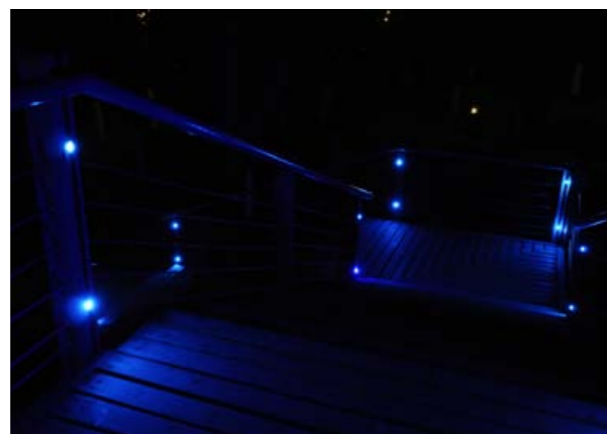

安装示意图 Installation Diagram

示例一: 单线出现, 点光源与电源线或电源控制线连接

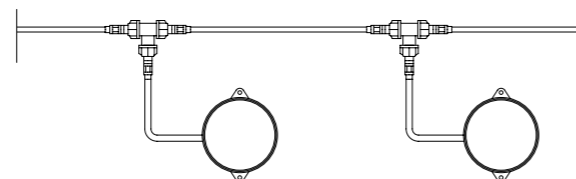

示例二: 点光源之间公母接头对接

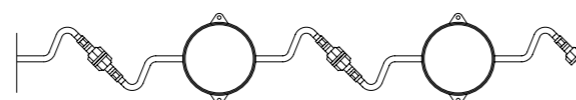

外形尺寸图 Dimension Diagram

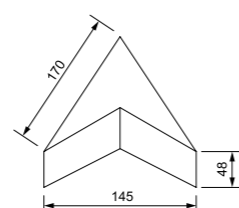

包装参数 Packaging Parameters

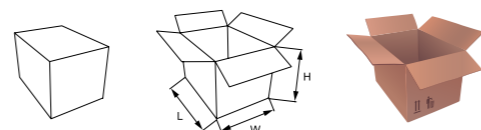

Item	Size(mm)	包装数量 Qty	外箱尺寸 Carton Size
BSD-DGY002		80PCS	620L×600W×270H

大功率 LED 点光源

High-power LED Point Source

BSD-DGY003

产品特点 Product Features

灯具电器一体化, 造型轻巧美观, 设计新颖, 安装简单, 可做各种单色, 白, 红, 绿, 黄, 蓝, 紫。

Integrated design of lighting and electrical appliance with the advantages of compact design, easy installation, optional various homochromy-white, red, green, yellow, blue, purple.

应用场合 Applications

适用于建筑物轮廓照明、桥梁、广告牌、商场、服装专卖店等局部照明场所。

Apply to building outline lighting, bridge, billboard, shopping mall, clothing specialty store and other local lighting place.

安装示意图 Installation Diagram

示例一: 单线出现, 点光源与电源线或电源控制线连接

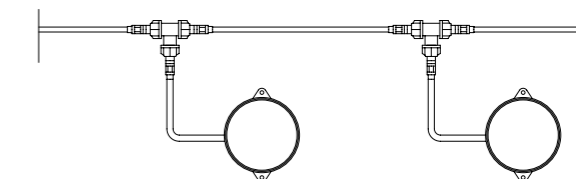

示例二: 点光源之间公母接头对接

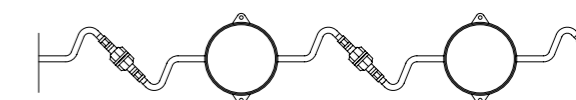

外形尺寸图 Dimension Diagram

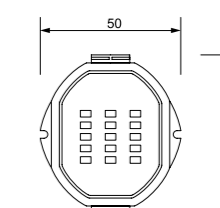

包装参数 Packaging Parameters

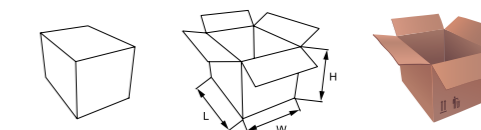

Item	Size(mm)	包装数量 Qty	外箱尺寸 Carton Size
BSD-DGY003		120PCS	520L×350W×350H

规格参数 Specifications

材 料 Material	Al
防护等级 IP Rating	IP65
功 率 Power (W)	1W
输入电压 Input Voltage (V)	DC24
光源类型 Light source Type	3528 LED
芯片尺寸 Chip Size (mil)	12*12
光源数量 Light Source Quantity (pcs)	15
光源光效 Luminous Efficiency (Lm/W)	90-130
显色指数 CRI	—
色 温 Color Temp (k)	RGB
环境温度 Environment Temperature (°C)	-40~45
使用寿命 Lifespan (h)	30000-80000

大功率 LED 点光源

High-power LED Point Source

BSD-DGY004

产品特点 Product Features

灯具电器一体化，造型轻巧美观，设计新颖，安装简单，可做各种单色，白，红，绿，黄，蓝，紫。

Integrated design of lighting and electrical appliance with the advantages of compact design, easy installation, optional various homochromy-white, red, green, yellow, blue, purple.

应用场合 Applications

适用于建筑物轮廓照明、桥梁、广告牌、商场、服装专卖店等局部照明场所。

Apply to building outline lighting, bridge, billboard, shopping mall, clothing specialty store and other local lighting place.

规格参数 Specifications

材 料 Material	Al
防护等级 IP Rating	IP65
功 率 Power (W)	4.8W
输入电压 Input Voltage (V)	DC24
光源类型 Light source Type	5050 LED
芯片尺寸 Chip Size (mil)	12*12
光源数量 Light Source Quantity (pcs)	24
光源光效 Luminous Efficiency (Lm/W)	90-130
显色指数 CRI	—
色 温 Color Temp (k)	RGB
环境温度 Environment Temperature (°C)	-40~45
使用寿命 Lifespan (h)	30000-80000



安装示意图 Installation Diagram

示例一：单线出现，点光源与电源线或电源控制线连接

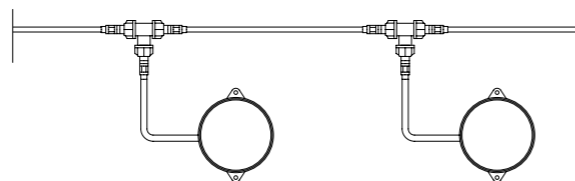

示例二：点光源之间公母接头对接

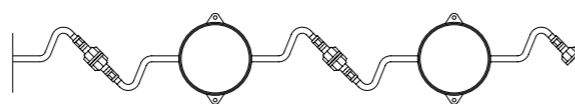

外形尺寸图 Dimension Diagram

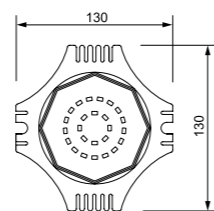

包装参数 Packaging Parameters

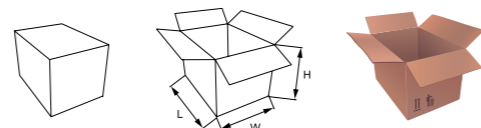

Item	Size(mm)	包装数量 Qty	外箱尺寸 Carton Size
BSD-DGY004		100PCS	520L×350W×350H

大功率 LED 点光源

High-power LED Point Source

BSD-DGY005

产品特点 Product Features

灯具电器一体化，造型轻巧美观，设计新颖，安装简单，可做各种单色，白，红，绿，黄，蓝，紫。

Integrated design of lighting and electrical appliance with the advantages of compact design, easy installation, optional various homochromy-white, red, green, yellow, blue, purple.

应用场合 Applications

适用于建筑物轮廓照明、桥梁、广告牌、商场、服装专卖店等局部照明场所。

Apply to building outline lighting, bridge, billboard, shopping mall, clothing specialty store and other local lighting place.

规格参数 Specifications

材 料 Material	Al
防护等级 IP Rating	IP65
功 率 Power (W)	1W
输入电压 Input Voltage (V)	12-240
光源类型 Light source Type	high power LED
芯片尺寸 Chip Size (mil)	45
光源数量 Light Source Quantity (pcs)	1
光源光效 Luminous Efficiency (Lm/W)	90-130
显色指数 CRI	—
色 温 Color Temp (k)	R Y B G W
环境温度 Environment Temperature (°C)	-40~45
使用寿命 Lifespan (h)	30000-80000

配光曲线 Light Distribution Curve

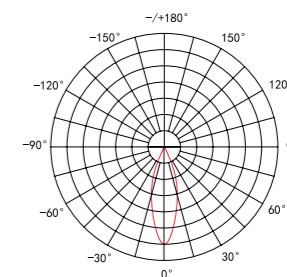

外形尺寸图 Dimension Diagram

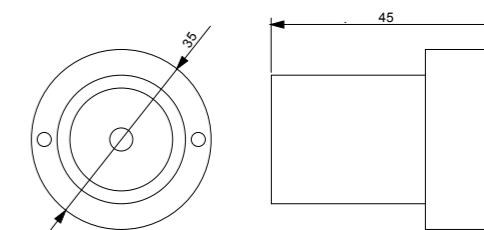

包装参数 Packaging Parameters

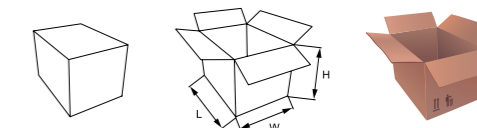

Item	Size(mm)	包装数量 Qty	外箱尺寸 Carton Size
BSD-DGY005		100PCS	225L×225W×230H



大功率 LED 点光源

High-power LED Point Source

BSD-DGY006



产品特点 Product Features

灯具电器一体化，造型轻巧美观，设计新颖，安装简单，可做各种单色，白，红，绿，黄，蓝，紫。

Integrated design of lighting and electrical appliance with the advantages of compact design, easy installation, optional various homochromy-white, red, green, yellow, blue, purple.

应用场合 Applications

适用于建筑物轮廓照明、桥梁、广告牌、商场、服装专卖店等局部照明场所。

Apply to building outline lighting, bridge, billboard, shopping mall, clothing specialty store and other local lighting place.

规格参数 Specifications

材 料 Material	Al
防护等级 IP Rating	IP65
功 率 Power (W)	3W
输入电压 Input Voltage (V)	12-240
光源类型 Light source Type	high power LED
芯片尺寸 Chip Size (mil)	45
光源数量 Light Source Quantity (pcs)	1
光源光效 Luminous Efficiency (Lm/W)	90-130
显色指数 CRI	—
色 温 Color Temp (k)	R Y B G W
环境温度 Environment Temperature (°C)	-40~45
使用寿命 Lifespan (h)	30000-80000

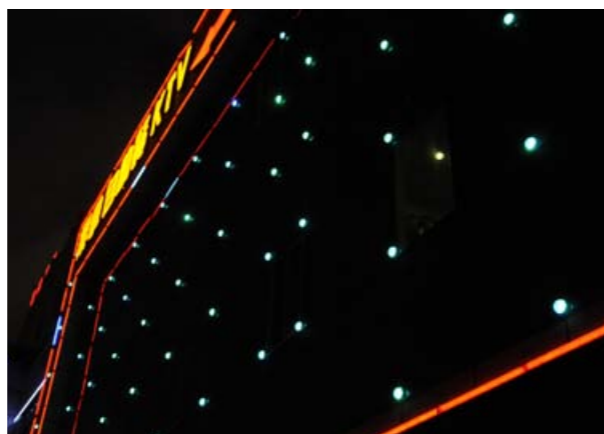

配光曲线 Light Distribution Curve

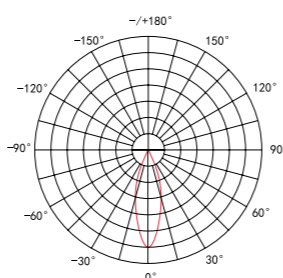

外形尺寸图 Dimension Diagram

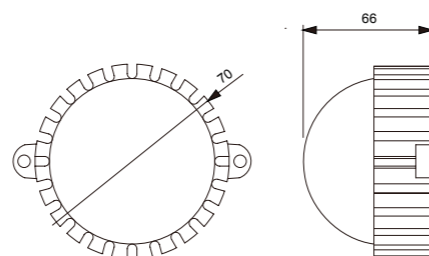

包装参数 Packaging Parameters

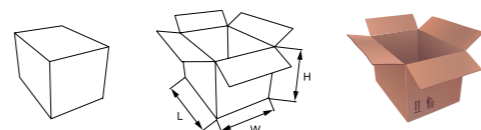

Item	Size(mm)	包装数量 Qty	外箱尺寸 Carton Size
BSD-DGY006		100PCS	400L×400W×320H



大功率 LED 点光源

High-power LED Point Source

BSD-DGY007



产品特点 Product Features

灯具电器一体化，造型轻巧美观，设计新颖，安装简单，可做各种单色，白，红，绿，黄，蓝，紫。

Integrated design of lighting and electrical appliance with the advantages of compact design, easy installation, optional various homochromy-white, red, green, yellow, blue, purple.

应用场合 Applications

适用于建筑物轮廓照明、桥梁、广告牌、商场、服装专卖店等局部照明场所。

Apply to building outline lighting, bridge, billboard, shopping mall, clothing specialty store and other local lighting place.

规格参数 Specifications

材 料 Material	Al
防护等级 IP Rating	IP65
功 率 Power (W)	3W
输入电压 Input Voltage (V)	12-240
光源类型 Light source Type	high power LED
芯片尺寸 Chip Size (mil)	45
光源数量 Light Source Quantity (pcs)	1
光源光效 Luminous Efficiency (Lm/W)	90-130
显色指数 CRI	—
色 温 Color Temp (k)	R Y B G W
环境温度 Environment Temperature (°C)	-40~45
使用寿命 Lifespan (h)	30000-80000

配光曲线 Light Distribution Curve

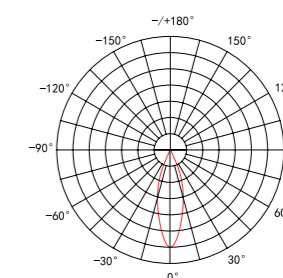

外形尺寸图 Dimension Diagram

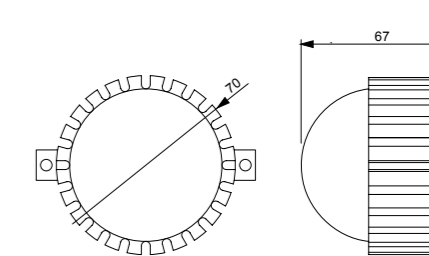

包装参数 Packaging Parameters

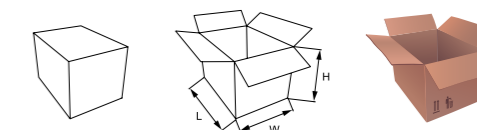

Item	Size(mm)	包装数量 Qty	外箱尺寸 Carton Size
BSD-DGY007		100PCS	400L×400W×320H

大功率 LED 点光源

High-power LED Point Source

BSD-DGY008

产品特点 Product Features

灯具电器一体化，造型轻巧美观，设计新颖，安装简单，可做各种单色，白，红，绿，黄，蓝，紫。

Integrated design of lighting and electrical appliance with the advantages of compact design, easy installation, optional various homochromy-white, red, green, yellow, blue, purple.

应用场合 Applications

适用于建筑物轮廓照明、桥梁、广告牌、商场、服装专卖店等局部照明场所。

Apply to building outline lighting, bridge, billboard, shopping mall, clothing specialty store and other local lighting place.

规格参数 Specifications

材 料 Material	Al
防护等级 IP Rating	IP65
功 率 Power (W)	3W
输入电压 Input Voltage (V)	12-240
光源类型 Light source Type	high power LED
芯片尺寸 Chip Size (mil)	45
光源数量 Light Source Quantity (pcs)	3
光源光效 Luminous Efficiency (Lm/W)	90-130
显色指数 CRI	—
色 温 Color Temp (k)	R Y B G W
环境温度 Environment Temperature (°C)	-40~45
使用寿命 Lifespan (h)	30000-80000



配光曲线 Light Distribution Curve

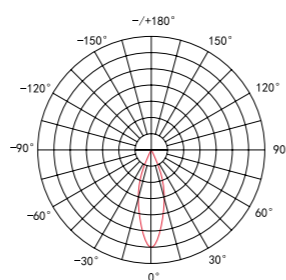

外形尺寸图 Dimension Diagram

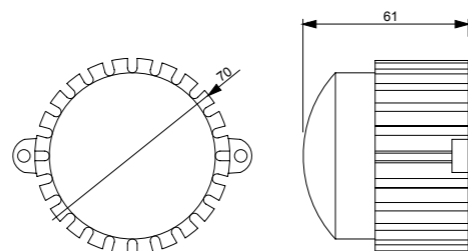

包装参数 Packaging Parameters

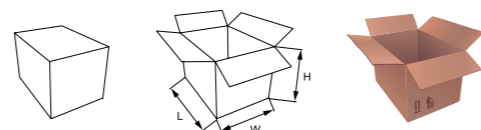

Item	Size(mm)	包装数量 Qty	外箱尺寸 Carton Size
BSD-DGY008		100PCS	400L×400W×300H

大功率 LED 点光源

High-power LED Point Source

BSD-DGY009

产品特点 Product Features

灯具电器一体化，造型轻巧美观，设计新颖，安装简单，可做各种单色，白，红，绿，黄，蓝，紫。

Integrated design of lighting and electrical appliance with the advantages of compact design, easy installation, optional various homochromy-white, red, green, yellow, blue, purple.

应用场合 Applications

适用于建筑物轮廓照明、桥梁、广告牌、商场、服装专卖店等局部照明场所。

Apply to building outline lighting, bridge, billboard, shopping mall, clothing specialty store and other local lighting place.

规格参数 Specifications

材 料 Material	Al
防护等级 IP Rating	IP65
功 率 Power (W)	3W
输入电压 Input Voltage (V)	12-240
光源类型 Light source Type	high power LED
芯片尺寸 Chip Size (mil)	45
光源数量 Light Source Quantity (pcs)	3
光源光效 Luminous Efficiency (Lm/W)	90-130
显色指数 CRI	—
色 温 Color Temp (k)	R Y B G W
环境温度 Environment Temperature (°C)	-40~45
使用寿命 Lifespan (h)	30000-80000

配光曲线 Light Distribution Curve

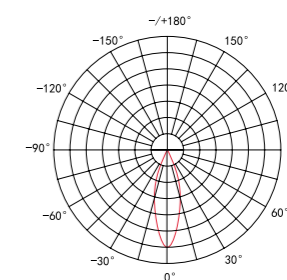

外形尺寸图 Dimension Diagram

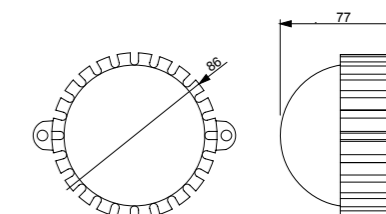

包装参数 Packaging Parameters

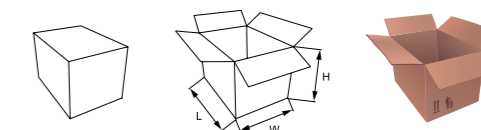

Item	Size(mm)	包装数量 Qty	外箱尺寸 Carton Size
BSD-DGY009		100PCS	480L×480W×360H

大功率 LED 点光源

High-power LED Point Source



产品特点 Product Features

灯具电器一体化，造型轻巧美观，设计新颖，安装简单，可做各种单色，白，红，绿，黄，蓝，紫。

Integrated design of lighting and electrical appliance with the advantages of compact design, easy installation, optional various homochromy-white, red, green, yellow, blue, purple.

应用场合 Applications

适用于建筑物轮廓照明、桥梁、广告牌、商场、服装专卖店等局部照明场所。

Apply to building outline lighting, bridge, billboard, shopping mall, clothing specialty store and other local lighting place.

规格参数 Specifications

材 料 Material	Al
防护等级 IP Rating	IP65
功 率 Power (W)	6W
输入电压 Input Voltage (V)	12-240
光源类型 Light source Type	high power LED
芯片尺寸 Chip Size (mil)	45
光源数量 Light Source Quantity (pcs)	6
光源光效 Luminous Efficiency (Lm/W)	90-130
显色指数 CRI	—
色 温 Color Temp (k)	R Y B G W
环境温度 Environment Temperature (°C)	-40~45
使用寿命 Lifespan (h)	30000-80000

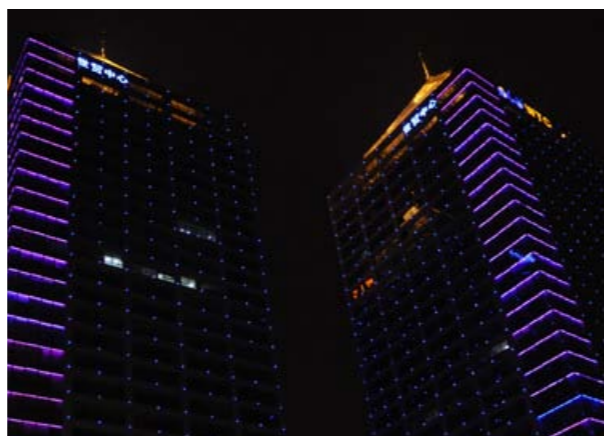

配光曲线 Light Distribution Curve

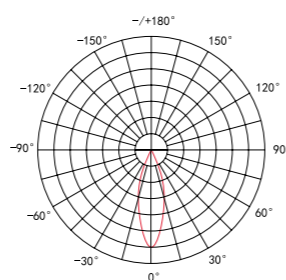

外形尺寸图 Dimension Diagram

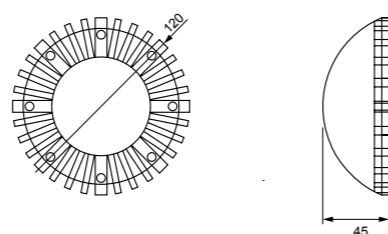

包装参数 Packaging Parameters

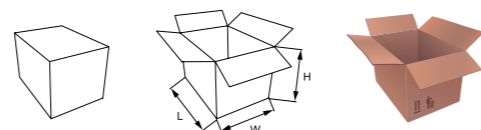

Item	Size(mm)	包装数量 Qty	外箱尺寸 Carton Size
BSD-DGY010		200PCS	290L×290W×280H

大功率 LED 点光源

High-power LED Point Source



产品特点 Product Features

灯具电器一体化，造型轻巧美观，设计新颖，安装简单，可做各种单色，白，红，绿，黄，蓝，紫。

Integrated design of lighting and electrical appliance with the advantages of compact design, easy installation, optional various homochromy-white, red, green, yellow, blue, purple.

应用场合 Applications

适用于建筑物轮廓照明、桥梁、广告牌、商场、服装专卖店等局部照明场所。

Apply to building outline lighting, bridge, billboard, shopping mall, clothing specialty store and other local lighting place.

规格参数 Specifications

材 料 Material	Al
防护等级 IP Rating	IP65
功 率 Power (W)	3W
输入电压 Input Voltage (V)	12-240
光源类型 Light source Type	high power LED
芯片尺寸 Chip Size (mil)	45
光源数量 Light Source Quantity (pcs)	3
光源光效 Luminous Efficiency (Lm/W)	90-130
显色指数 CRI	80
色 温 Color Temp (k)	2800-7000
环境温度 Environment Temperature (°C)	-40~45
使用寿命 Lifespan (h)	30000-80000

配光曲线 Light Distribution Curve

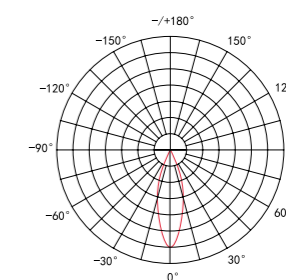

外形尺寸图 Dimension Diagram

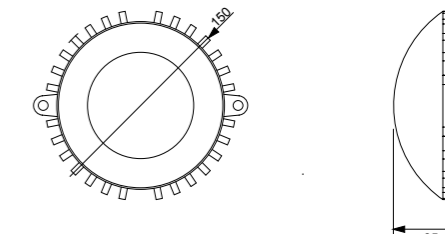

包装参数 Packaging Parameters

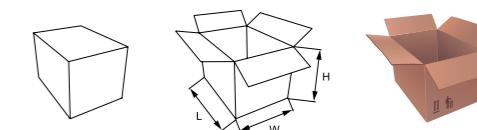

Item	Size(mm)	包装数量 Qty	外箱尺寸 Carton Size
BSD-DGY011		18PCS	500L×350W×310H

大功率 LED 点光源

High-power LED Point Source



产品特点 Product Features

灯具电器一体化, 造型轻巧美观, 设计新颖, 安装简单, 可做各种单色, 白, 红, 绿, 黄, 蓝, 紫。

Integrated design of lighting and electrical appliance with the advantages of compact design, easy installation, optional various homochromy-white, red, green, yellow, blue, purple.

应用场合 Applications

适用于建筑物轮廓照明、桥梁、广告牌、商场、服装专卖店等局部照明场所。

Apply to building outline lighting, bridge, billboard, shopping mall, clothing specialty store and other local lighting place.

规格参数 Specifications

材 料 Material	Al
防护等级 IP Rating	IP65
功 率 Power (W)	6W
输入电压 Input Voltage (V)	12-24V
光源类型 Light source Type	high power LED
芯片尺寸 Chip Size (mil)	45
光源数量 Light Source Quantity (pcs)	6
光源光效 Luminous Efficiency (Lm/W)	90-130
显色指数 CRI	80
色 温 Color Temp (k)	2800-7000
环境温度 Environment Temperature (°C)	-40~45
使用寿命 Lifespan (h)	30000-80000

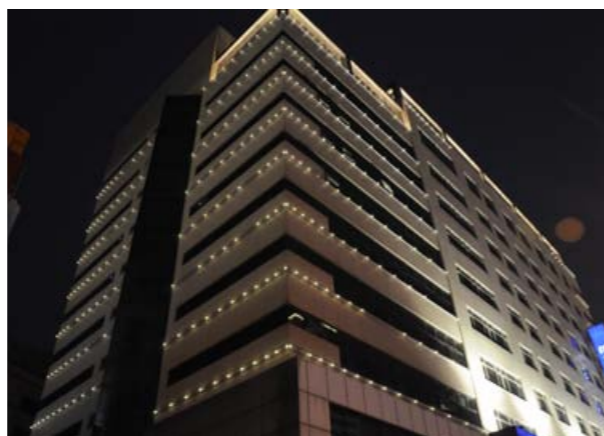

配光曲线 Light Distribution Curve

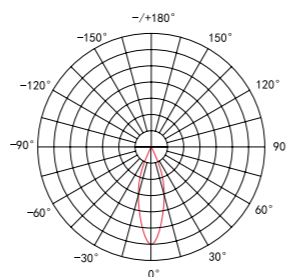

外形尺寸图 Dimension Diagram

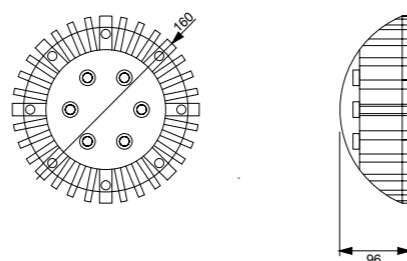

包装参数 Packaging Parameters

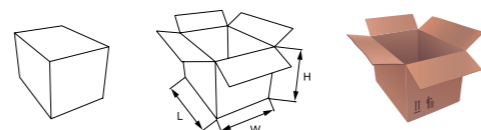

Item	Size(mm)	包装数量 Qty	外箱尺寸 Carton Size
BSD-DGY012		18PCS	530L×370W×340H

LED 模组

LED Module

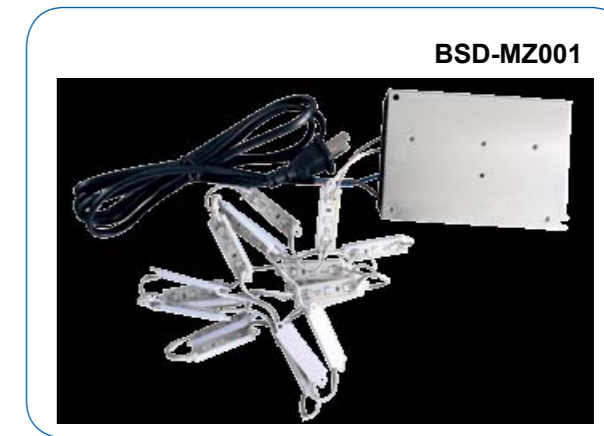

产品特点 Product Features

具有体积小、安全低电压、寿命长、电光转换效率高、响应速度快、节能、环保等优良特性, 能适应各种几何尺寸和不同空间大小的装饰照明要求, LED模组光照强、光色一致性佳、色彩饱和度好、寿命长、抗震好,低光衰。安装维护成本低。

It has lots of advantages, such as small size, safe low voltage, long lifespan, high electro-optic conversion efficiency, high response speed, energy saving, environmental protection. It can meet all the decorative lighting requirements of different geometric dimensions and space sizes. LED module has good light color consistence, excellent color saturation, long lifespan, good anti-seismic, low luminous decay and low maintenance cost.

应用场合 Applications

主要用于展示广告字体和标识的夜间效果, 它以文字或标识为媒介, 安装在楼宇顶部或墙面。

Apply to displaying advertising characters and marks at night. Using words or marks as media, which is installed in the building top or metope.

规格参数 Specifications

材 料 Material	FR-4
防护等级 IP Rating	IP65
功 率 Power (W)	0.48W
输入电压 Input Voltage (V)	12
光源类型 Light source Type	3528 LED
芯片尺寸 Chip Size (mil)	12*12
光源数量 Light Source Quantity (pcs)	4
光源光效 Luminous Efficiency (Lm/W)	90-130
显色指数 CRI	—
色 温 Color Temp (k)	R / Y / G / B / W
环境温度 Environment Temperature (°C)	-40~45
使用寿命 Lifespan (h)	30000-80000

配光曲线 Light Distribution Curve

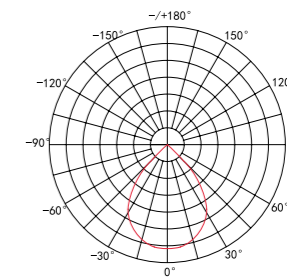

外形尺寸图 Dimension Diagram

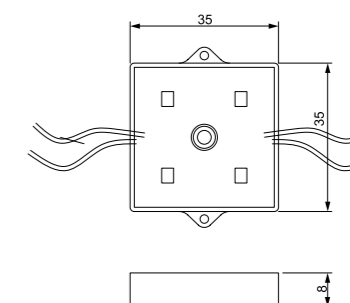

包装参数 Packaging Parameters

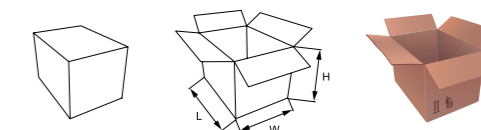

Item	Size(mm)	包装数量 Qty	外箱尺寸 Carton Size
BSD-MZ001		500PCS	215L×215W×215H



LED 模组

LED Module

BSD-MZ002

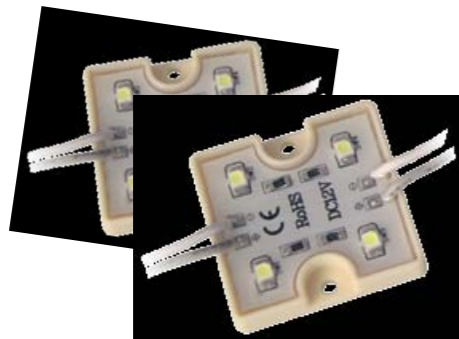

产品特点 Product Features

具有体积小、安全低电压、寿命长、电光转换效率高、响应速度快、节能、环保等优良特性，能适应各种几何尺寸和不同空间大小的装饰照明要求，LED模组光照强、光色一致性佳、色彩饱和度好、寿命长、抗震好，低光衰。安装维护成本低。

It has lots of advantages, such as small size, safe low voltage, long lifespan, high electro-optic conversion efficiency, high response speed, energy saving, environmental protection. It can meet all the decorative lighting requirements of different geometric dimensions and space sizes. LED module has good light color consistence, excellent color saturation, long lifespan, good anti-seismic, low luminous decay and low maintenance cost.

应用场合 Applications

主要用于展示广告字体和标识的夜间效果，它以文字或标识为媒介，安装在楼宇顶部或墙面。

Apply to displaying advertising characters and marks at night. Using words or marks as media, which is installed in the building top or metope.

规格参数 Specifications

材 料 Material	FR-4
防护等级 IP Rating	IP65
功 率 Power (W)	0.48W
输入电压 Input Voltage (V)	12
光源类型 Light source Type	3528 LED
芯片尺寸 Chip Size (mil)	12*12
光源数量 Light Source Quantity (pcs)	4
光源光效 Luminous Efficiency (Lm/W)	90-130
显色指数 CRI	—
色 温 Color Temp (k)	R / Y / G / B / W
环境温度 Environment Temperature (°C)	-40~45
使用寿命 Lifespan (h)	30000-80000



配光曲线 Light Distribution Curve

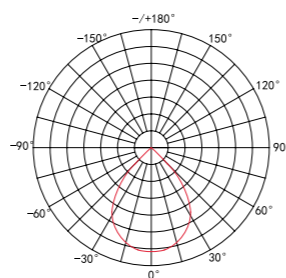

外形尺寸图 Dimension Diagram

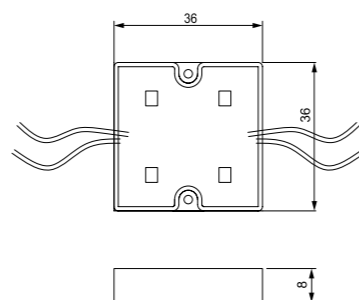

包装参数 Packaging Parameters

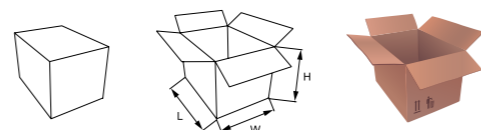

Item	Size(mm)	包装数量 Qty	外箱尺寸 Carton Size
BSD-MZ002		500PCS	215L×215W×215H

LED 模组

LED Module



BSD-MZ003



产品特点 Product Features

具有体积小、安全低电压、寿命长、电光转换效率高、响应速度快、节能、环保等优良特性，能适应各种几何尺寸和不同空间大小的装饰照明要求，LED模组光照强、光色一致性佳、色彩饱和度好、寿命长、抗震好，低光衰。安装维护成本低。

It has lots of advantages, such as small size, safe low voltage, long lifespan, high electro-optic conversion efficiency, high response speed, energy saving, environmental protection. It can meet all the decorative lighting requirements of different geometric dimensions and space sizes. LED module has good light color consistence, excellent color saturation, long lifespan, good anti-seismic, low luminous decay and low maintenance cost.

应用场合 Applications

主要用于展示广告字体和标识的夜间效果，它以文字或标识为媒介，安装在楼宇顶部或墙面。

Apply to displaying advertising characters and marks at night. Using words or marks as media, which is installed in the building top or metope.

规格参数 Specifications

材 料 Material	FR-4
防护等级 IP Rating	IP65
功 率 Power (W)	0.96W
输入电压 Input Voltage (V)	12
光源类型 Light source Type	5050 LED
芯片尺寸 Chip Size (mil)	12*12
光源数量 Light Source Quantity (pcs)	4
光源光效 Luminous Efficiency (Lm/W)	90-130
显色指数 CRI	—
色 温 Color Temp (k)	R / Y / G / B / W
环境温度 Environment Temperature (°C)	-40~45
使用寿命 Lifespan (h)	30000-80000

配光曲线 Light Distribution Curve

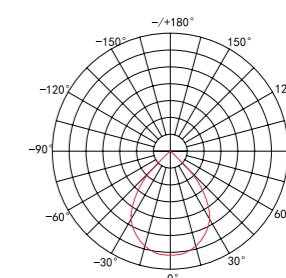

外形尺寸图 Dimension Diagram

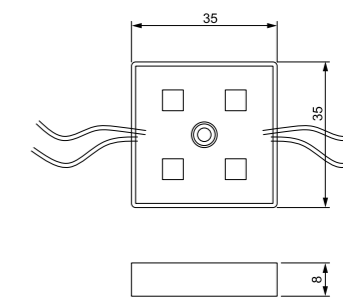

包装参数 Packaging Parameters

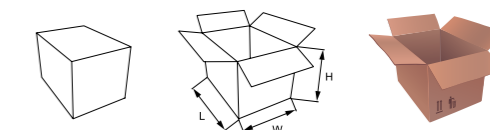

Item	Size(mm)	包装数量 Qty	外箱尺寸 Carton Size
BSD-MZ003		500PCS	215L×215W×215H



LED 模组

LED Module

BSD-MZ004



产品特点 Product Features

具有体积小、安全低电压、寿命长、电光转换效率高、响应速度快、节能、环保等优良特性，能适应各种几何尺寸和不同空间大小的装饰照明要求，LED模组光照强、光色一致性佳、色彩饱和度好、寿命长、抗震好，低光衰。安装维护成本低。

It has lots of advantages, such as small size, safe low voltage, long lifespan, high electro-optic conversion efficiency, high response speed, energy saving, environmental protection. It can meet all the decorative lighting requirements of different geometric dimensions and space sizes. LED module has good light color consistence, excellent color saturation, long lifespan, good anti-seismic, low luminous decay and low maintenance cost.

应用场合 Applications

主要用于展示广告字体和标识的夜间效果，它以文字或标识为媒介，安装在楼宇顶部或墙面。

Apply to displaying advertising characters and marks at night. Using words or marks as media, which is installed in the building top or metope.

规格参数 Specifications

材 料 Material	FR-4
防护等级 IP Rating	IP65
功 率 Power (W)	0.48W
输入电压 Input Voltage (V)	12
光源类型 Light source Type	3528 LED
芯片尺寸 Chip Size (mil)	12*12
光源数量 Light Source Quantity (pcs)	4
光源光效 Luminous Efficiency (Lm/W)	90-130
显色指数 CRI	—
色 温 Color Temp (k)	RGB
环境温度 Environment Temperature (°C)	-40~45
使用寿命 Lifespan (h)	30000-80000



配光曲线 Light Distribution Curve

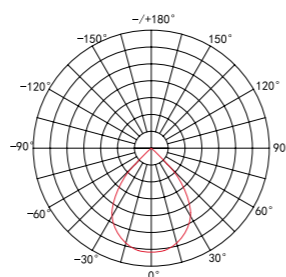

外形尺寸图 Dimension Diagram

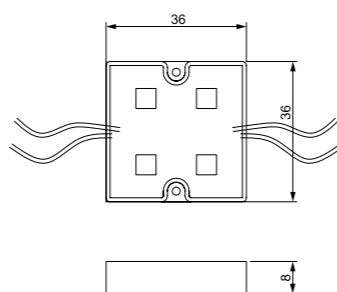

包装参数 Packaging Parameters

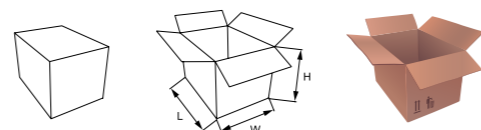

Item	Size(mm)	包装数量 Qty	外箱尺寸 Carton Size
BSD-MZ004		500PCS	215L×215W×215H



产品特点 Product Features

具有体积小、安全低电压、寿命长、电光转换效率高、响应速度快、节能、环保等优良特性，能适应各种几何尺寸和不同空间大小的装饰照明要求，LED模组光照强、光色一致性佳、色彩饱和度好、寿命长、抗震好，低光衰。安装维护成本低。

It has lots of advantages, such as small size, safe low voltage, long lifespan, high electro-optic conversion efficiency, high response speed, energy saving, environmental protection. It can meet all the decorative lighting requirements of different geometric dimensions and space sizes. LED module has good light color consistence, excellent color saturation, long lifespan, good anti-seismic, low luminous decay and low maintenance cost.

应用场合 Applications

主要用于展示广告字体和标识的夜间效果，它以文字或标识为媒介，安装在楼宇顶部或墙面。

Apply to displaying advertising characters and marks at night. Using words or marks as media, which is installed in the building top or metope.

规格参数 Specifications

材 料 Material	FR-4
防护等级 IP Rating	IP65
功 率 Power (W)	1W
输入电压 Input Voltage (V)	12
光源类型 Light source Type	M5 LED
芯片尺寸 Chip Size (mil)	12*12
光源数量 Light Source Quantity (pcs)	9
光源光效 Luminous Efficiency (Lm/W)	90-130
显色指数 CRI	—
色 温 Color Temp (k)	全彩 Full Color
环境温度 Environment Temperature (°C)	-40~45
使用寿命 Lifespan (h)	30000-80000

LED 模组

LED Module



BSD-MZ005



配光曲线 Light Distribution Curve

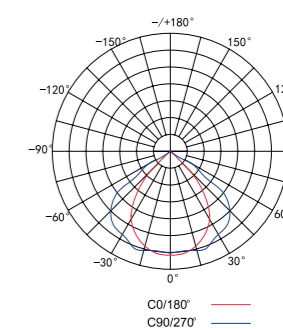

外形尺寸图 Dimension Diagram

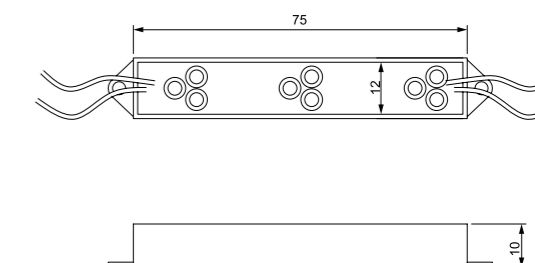

包装参数 Packaging Parameters

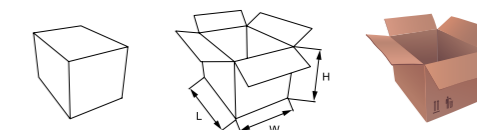

Item	Size(mm)	包装数量 Qty	外箱尺寸 Carton Size
BSD-MZ005		1000PCS	415L×315W×165H