

LED 封装产品

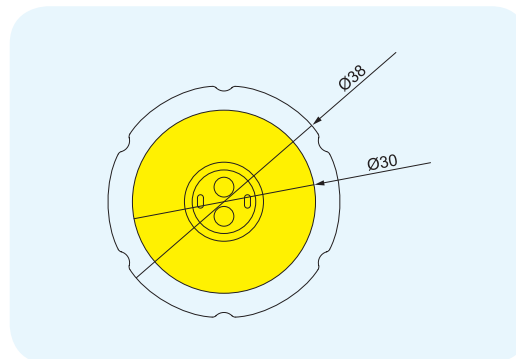

Light Packaging Product

BSD-C007



规格参数 Specifications

Part Number 型号	Dimensions (mm) 尺寸	Luminous Surface Dimensions (mm) 发光面尺寸	Input Voltage (V) 输入电压	Power (W) 功率	Luminous Efficiency (Lm/W) 光源光效	Color Temp (k) 色温	CRI 显色指数
BSD-C007	φ 38 × 1	φ 30-15	DC120V80mA	10	60-90	3000-6000	60-85

BSD-C008

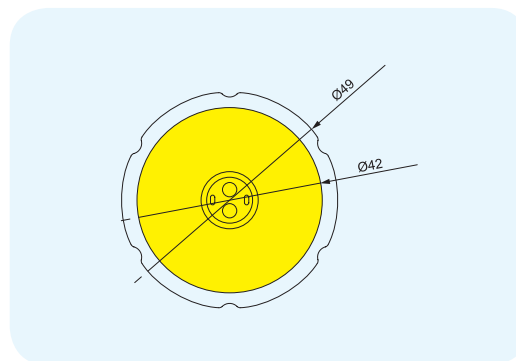

规格参数 Specifications

Part Number 型号	Dimensions (mm) 尺寸	Luminous Surface Dimensions (mm) 发光面尺寸	Input Voltage (V) 输入电压	Power (W) 功率	Luminous Efficiency (Lm/W) 光源光效	Color Temp (k) 色温	CRI 显色指数
BSD-C008	φ 49 × 1	φ 42-15	DC72V130mA	10	60-100	3000-6000	60-85



LED 封装产品

Light Packaging Product

BSD-C009

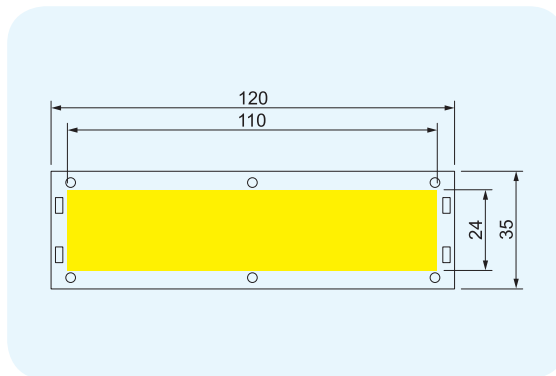
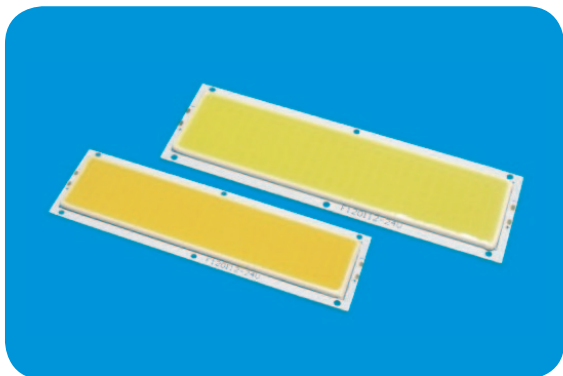

- BSD-C010
- BSD-C011
- BSD-C012

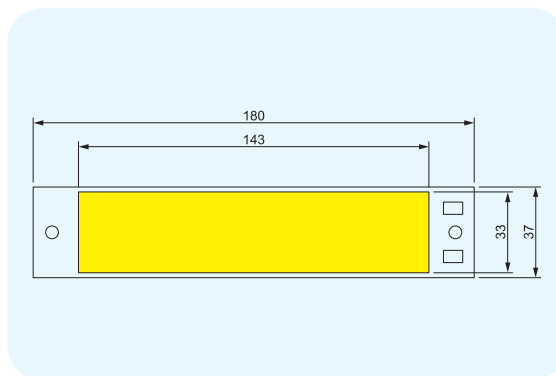
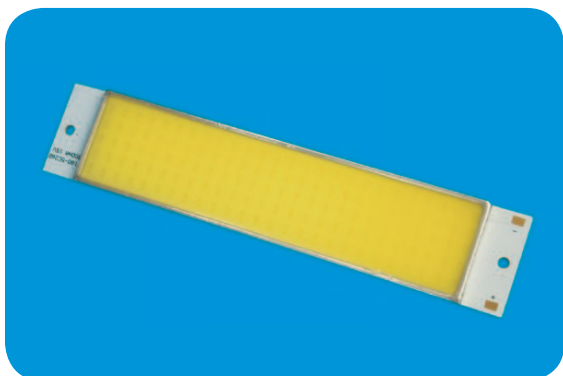

规格参数 Specifications

Part Number 型号	Dimensions (mm) 尺寸	Luminous Surface Dimensions (mm) 发光面尺寸	Input Voltage (V) 输入电压	Power (W) 功率	Luminous Efficiency (Lm/W) 光源光效	Color Temp (k) 色温	CRI 显色指数
BSD-C009	120 × 35	110 × 24	DC24V280mA	6.7	70-100	3000-6000	60-85
BSD-C010	180 × 37	143 × 33	DC15V520mA	7.8	70-100	3000-6000	60-85
BSD-C011	180 × 37	143 × 33	DC15V670mA	10	70-100	3000-6000	60-85
BSD-C012	180 × 37	143 × 33	DC15V1000mA	15	70-100	3000-6000	60-85

LED 日光灯



LED Light Tube



外形尺寸图 Dimension Diagram

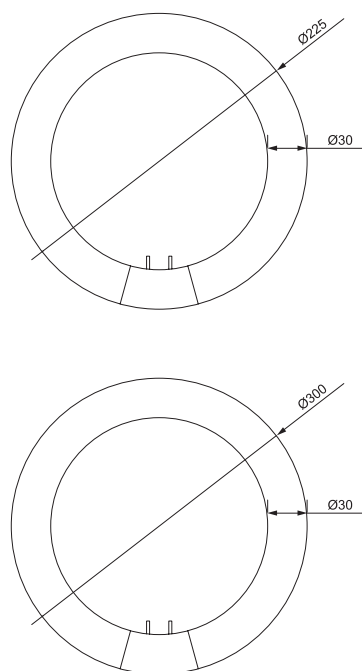

包装参数 Packaging Parameters

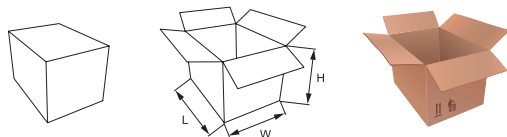

Item	Size(mm)	包装数量 Qty	外箱尺寸 Carton Size
BSD-RG001		20PCS	600L×340W×240H
BSD-RG002		20PCS	600L×340W×340H

产品特点 Product Features

耐用、节能、免维护，无须经常更换灯管、镇流器、启辉器，绿色环保，光线柔和，光谱纯，有助于集中精力，提高效率。

Durable, energy saving, maintenance free, no need to change tubes, ballast and starter often. Environmental protection, soft light, pure light spectrum. Be useful to concentrate and improve working efficiency.

应用场合 Applications

大型工厂，医院，教室，家庭，生产车间，工作台，办公室室内照明，商场超市室内照明。

Apply to indoor lighting of large factory, hospital, classroom, home, manufacturing shop, gallery, office and market.

规格参数 Specifications

型号 Type	RG001 / RG002
材料 Material	Al
防护等级 IP Rating	IP40
功率 Power (W)	12W / 18W
输入电压 Input Voltage (V)	85-265
光源类型 Light source Type	3528LED
芯片尺寸 Chip Size (mil)	12*12
光源数量 Light Source Quantity (pcs)	160 / 288
光源光效 Luminous Efficiency (Lm/W)	90-130
显色指数 CRI	80
色温 Color Temp (k)	2800-7000
环境温度 Environment Temperature (°C)	-40~45
使用寿命 Lifespan (h)	30000-80000



LED 日光灯

LED Light Tube

BSD-RG003



BSD-RG004



产品特点 Product Features

耐用、节能、免维护，无须经常更换灯管、镇流器、启辉器，绿色环保，光线柔和，光谱纯，有助于集中精力，提高效率。

Durable, energy saving, maintenance free, no need to change tubes, ballast and starter often. Environmental protection, soft light, pure light spectrum. Be useful to concentrate and improve working efficiency.

应用场合 Applications

大型工厂，医院，教室，家庭，生产车间，工作台，办公室室内照明，商场超市室内照明。

Apply to indoor lighting of large factory, hospital, classroom, home, manufacturing shop, gallery, office and market.

规格参数 Specifications

型号 Type	RG003 / RG004
材料 Material	Al
防护等级 IP Rating	IP40
功率 Power (W)	16W / 20W
输入电压 Input Voltage (V)	100-240
光源类型 Light source Type	3528LED
芯片尺寸 Chip Size (mil)	12*12
光源数量 Light Source Quantity (pcs)	228 / 276
光源光效 Luminous Efficiency (Lm/W)	90-130
显色指数 CRI	80
色温 Color Temp (k)	2800-7000
环境温度 Environment Temperature (°C)	-40~45
使用寿命 Lifespan (h)	30000-80000

外形尺寸图 Dimension Diagram

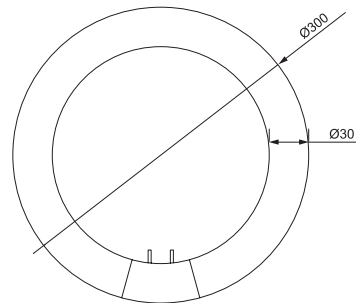
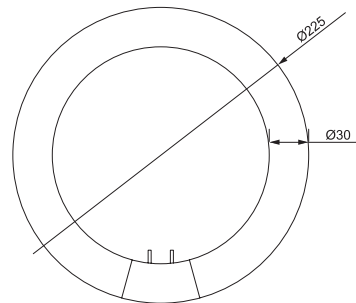

包装参数 Packaging Parameters

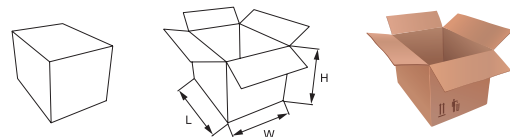

Item	Size(mm)	包装数量 Qty	外箱尺寸 Carton Size
BSD-RG003		20PCS	490L×370W×250H
BSD-RG004		20PCS	630L×370W×350H

LED 日光灯

LED Light Tube

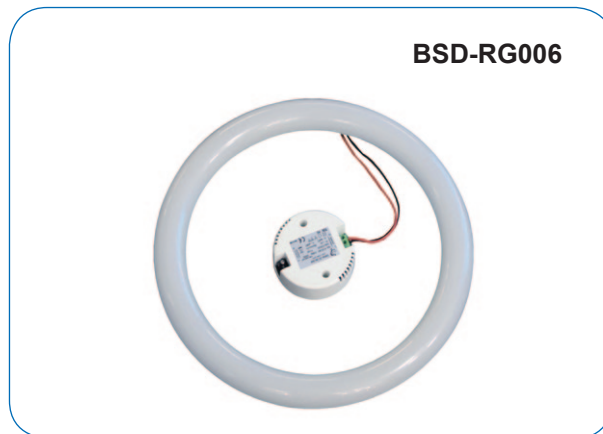
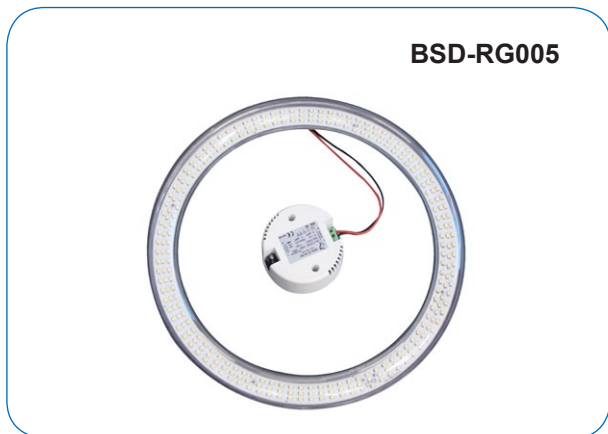

外形尺寸图 Dimension Diagram

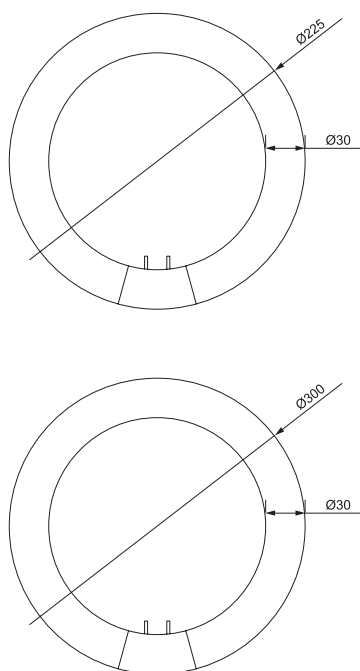

包装参数 Packaging Parameters

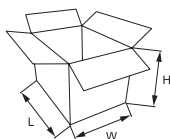
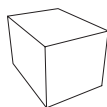

Item	Size(mm)	包装数量 Qty	外箱尺寸 Carton Size
BSD-RG005		20PCS	490L×370W×250H
BSD-RG006		20PCS	630L×370W×350H

产品特点 Product Features

耐用、节能、免维护，无须经常更换灯管、镇流器、启辉器，绿色环保，光线柔和，光谱纯，有助于集中精力，提高效率。

Durable, energy saving, maintenance free, no need to change tubes, ballast and starter often. Environmental protection, soft light, pure light spectrum. Be useful to concentrate and improve working efficiency.

应用场合 Applications

大型工厂，医院，教室，家庭，生产车间，工作台，办公室室内照明，商场超市室内照明。

Apply to indoor lighting of large factory, hospital, classroom, home, manufacturing shop, gallery, office and market.

规格参数 Specifications

型号 Type	RG005 / RG006
材料 Material	Al
防护等级 IP Rating	IP40
功率 Power (W)	16W / 20W
输入电压 Input Voltage (V)	100-240
光源类型 Light source Type	3528LED
芯片尺寸 Chip Size (mil)	12*12
光源数量 Light Source Quantity (pcs)	228 / 276
光源光效 Luminous Efficiency (Lm/W)	90-130
显色指数 CRI	80
色温 Color Temp (k)	2800-7000
环境温度 Environment Temperature (°C)	-40~45
使用寿命 Lifespan (h)	30000-80000



LED 日光灯

LED Light Tube

BSD-RG007



BSD-RG008



产品特点 Product Features

耐用、节能、免维护，无须经常更换灯管、镇流器、启辉器，绿色环保，光线柔和，光谱纯，有助于集中精力，提高效率。

Durable, energy saving, maintenance free, no need to change tubes, ballast and starter often. Environmental protection, soft light, pure light spectrum. Be useful to concentrate and improve working efficiency.

应用场合 Applications

大型工厂，医院，教室，家庭，生产车间，工作台，办公室室内照明，商场超市室内照明。

Apply to indoor lighting of large factory, hospital, classroom, home, manufacturing shop, gallery, office and market.

规格参数 Specifications

型号 Type	RG007 / RG008
材料 Material	Al
防护等级 IP Rating	IP40
功率 Power (W)	9W / 19W
输入电压 Input Voltage (V)	220
光源类型 Light source Type	COB LED
芯片尺寸 Chip Size (mil)	45
光源数量 Light Source Quantity (pcs)	1 / 1
光源光效 Luminous Efficiency (Lm/W)	90-130
显色指数 CRI	80
色温 Color Temp (k)	2800-7000
环境温度 Environment Temperature (°C)	-40~45
使用寿命 Lifespan (h)	30000-80000

外形尺寸图 Dimension Diagram

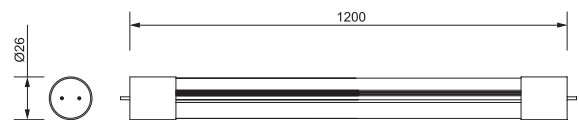
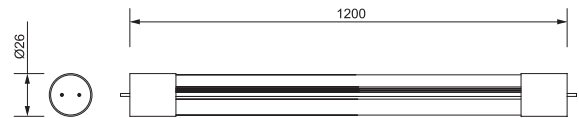

包装参数 Packaging Parameters

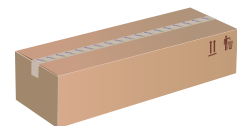
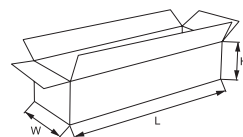

Item	Size(mm)	包装数量 Qty	外箱尺寸 Carton Size
BSD-RG007		25PCS	645L×210W×215H
BSD-RG008		25PCS	1250L×215W×210H

LED 日光灯

LED Light Tube



外形尺寸图 Dimension Diagram

产品特点 Product Features

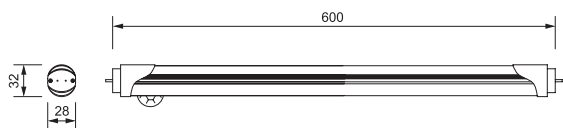

耐用、节能、免维护，无须经常更换灯管、镇流器、启辉器，绿色环保，光线柔和，光谱纯，有助于集中精力，提高效率。

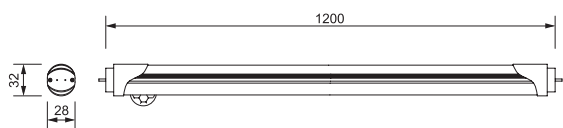

Durable, energy saving, maintenance free, no need to change tubes, ballast and starter often. Environmental protection, soft light, pure light spectrum. Be useful to concentrate and improve working efficiency.

包装参数 Packaging Parameters

应用场合 Applications

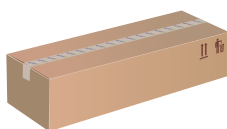
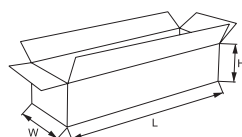

大型工厂，医院，教室，家庭，生产车间，工作台，办公室室内照明，商场超市室内照明。

Apply to indoor lighting of large factory, hospital, classroom, home, manufacturing shop, gallery, office and market.

规格参数 Specifications

Item	Size(mm)	包装数量 Qty	外箱尺寸 Carton Size
BSD-RG009		25PCS	1250L×215W×210H
BSD-RG010		25PCS	1250L×215W×210H

型号 Type	RG009 / RG010
材料 Material	Al
防护等级 IP Rating	IP40
功率 Power (W)	9W / 18W
输入电压 Input Voltage (V)	85-265
光源类型 Light source Type	COB LED
芯片尺寸 Chip Size (mil)	12*12
光源数量 Light Source Quantity (pcs)	1 / 1
光源光效 Luminous Efficiency (Lm/W)	90-130
显色指数 CRI	80
色温 Color Temp (k)	2800-7000
环境温度 Environment Temperature (°C)	-40~45
使用寿命 Lifespan (h)	30000-80000



LED 日光灯

LED Light Tube

BSD-RG011



BSD-RG012



产品特点 Product Features

耐用、节能、免维护，无须经常更换灯管、镇流器、启辉器，绿色环保，光线柔和，光谱纯，有助于集中精力，提高效率。

Durable, energy saving, maintenance free, no need to change tubes, ballast and starter often. Environmental protection, soft light, pure light spectrum. Be useful to concentrate and improve working efficiency.

应用场合 Applications

大型工厂，医院，教室，家庭，生产车间，工作台，办公室室内照明，商场超市室内照明。

Apply to indoor lighting of large factory, hospital, classroom, home, manufacturing shop, gallery, office and market.

规格参数 Specifications

型号 Type	RG011 / RG012
材料 Material	Al
防护等级 IP Rating	IP40
功率 Power (W)	9W / 18W
输入电压 Input Voltage (V)	85-265
光源类型 Light source Type	3528LED
芯片尺寸 Chip Size (mil)	12*12
光源数量 Light Source Quantity (pcs)	1 / 1
光源光效 Luminous Efficiency (Lm/W)	90-130
显色指数 CRI	80
色温 Color Temp (k)	2800-7000
环境温度 Environment Temperature (°C)	-40~45
使用寿命 Lifespan (h)	30000-80000

外形尺寸图 Dimension Diagram

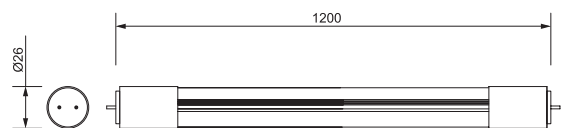
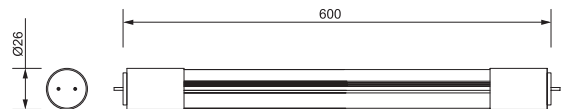

包装参数 Packaging Parameters

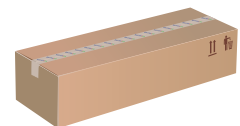
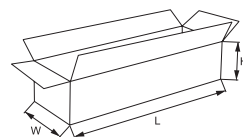

Item	Size(mm)	包装数量 Qty	外箱尺寸 Carton Size
BSD-RG011		25PCS	645L×210W×215H
BSD-RG012		25PCS	1250L×215W×210H

LED 日光灯



LED Light Tube



BSD-RG013
BSD-RG014

外形尺寸图 Dimension Diagram

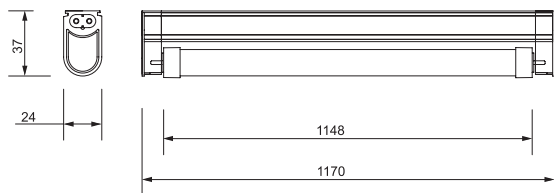
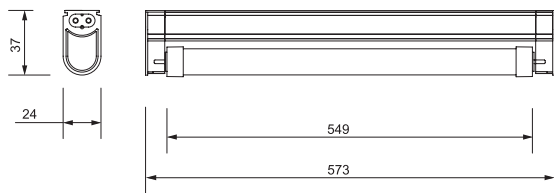

包装参数 Packaging Parameters

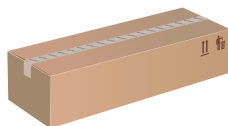
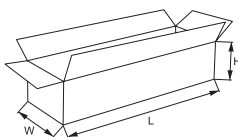

Item	Size(mm)	包装数量 Qty	外箱尺寸 Carton Size
BSD-RG013		25PCS	645L×210W×215H
BSD-RG014		25PCS	1250L×215W×210H

产品特点 Product Features

耐用、节能、免维护，无须经常更换灯管、镇流器、启辉器，绿色环保，光线柔和，光谱纯，有助于集中精力，提高效率。

Durable, energy saving, maintenance free, no need to change tubes, ballast and starter often. Environmental protection, soft light, pure light spectrum. Be useful to concentrate and improve working efficiency.

应用场合 Applications

大型工厂，医院，教室，家庭，生产车间，工作台，办公室室内照明，商场超市室内照明。

Apply to indoor lighting of large factory, hospital, classroom, home, manufacturing shop, gallery, office and market.

规格参数 Specifications

型号 Type	RG013 / RG014
材料 Material	Al
防护等级 IP Rating	IP40
功率 Power (W)	7W / 14W
输入电压 Input Voltage (V)	85-265
光源类型 Light source Type	3528LED
芯片尺寸 Chip Size (mil)	12*12
光源数量 Light Source Quantity (pcs)	90 / 192
光源光效 Luminous Efficiency (Lm/W)	90-130
显色指数 CRI	80
色温 Color Temp (k)	2800-7000
环境温度 Environment Temperature (°C)	-40~45
使用寿命 Lifespan (h)	30000-80000