

LED 天花板灯

LED Ceiling Light

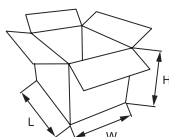
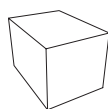
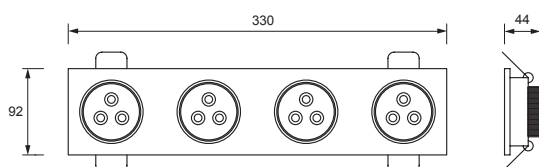
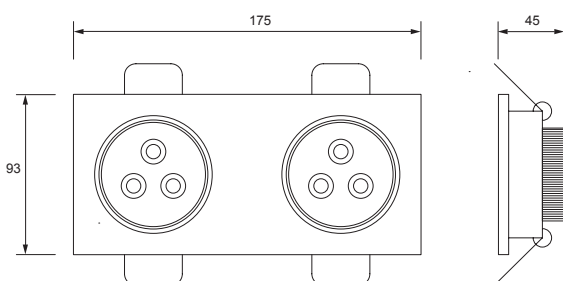

Item	Size(mm)	包装数量 Qty	外箱尺寸 Carton Size
BSD-TH040		100PCS	765L×595W×470H
BSD-TH041		100PCS	715L×600W×470H

白光LED的能耗仅为白炽灯的1/10，节能灯的1/4，寿命长，寿命可达10万小时以上，采用固态封装，采用铝材成型，良好的散热结构，属于冷光源类型，安装和运输都很方便，表面温度低，无明火隐患。

Energy saving, the energy consumption of white-light LED takes only 1/10 of filament lamp, and 1/4 of energy saving lamp. Long lifespan, more than 100,000 hours. Using solid encapsulation, aluminum molding, excellent heat dissipation, cold light source, easy installation and convenient delivery, low surface temperature and no fire hazards.

适用于汽车展示、珠宝首饰、高档服饰、专业橱窗、柜台等重点照明场所。

Apply to car, jewelry and high-end dress and professional showcase, sales counter showing and important lighting areas.

型号 Type	TH040 / TH041
材料 Material	Al
防护等级 IP Rating	IP40
功率 Power (W)	6W / 12W
输入电压 Input Voltage (V)	85-265
光源类型 Light source Type	high power LED
芯片尺寸 Chip Size (mil)	45
光源数量 Light Source Quantity (pcs)	6 / 12
光源光效 Luminous Efficiency (Lm/W)	90-130
显色指数 CRI	80
色温 Color Temp (k)	2800-7000
环境温度 Environment Temperature (°C)	-40~45
使用寿命 Lifespan (h)	30000-80000



LED 天花灯

LED Ceiling Light

BSD-TH042



BSD-TH043



产品特点 Product Features

白光LED的能耗仅为白炽灯的1/10, 节能灯的1/4, 寿命长, 寿命可达10万小时以上, 采用固态封装, 采用铝材成型, 良好的散热结构, 属于冷光源类型, 安装和运输都很方便, 表面温度低, 无明火隐患。

Energy saving, the energy consumption of white-light LED takes only 1/10 of filament lamp, and 1/4 of energy saving lamp. Long lifespan, more than 100,000 hours. Using solid encapsulation, aluminum molding, excellent heat dissipation, cold light source, easy installation and convenient delivery, low surface temperature and no fire hazards.

应用场合 Applications

适用于汽车展示、珠宝首饰、高档服饰、专业橱窗、柜台等重点照明场所。

Apply to car, jewelry and high-end dress and professional showcase, sales counter showing and important lighting areas.

规格参数 Specifications

型号 Type	TH042 / TH043
材料 Material	Al
防护等级 IP Rating	IP40
功率 Power (W)	4W / 3W
输入电压 Input Voltage (V)	85-265
光源类型 Light source Type	high power LED
芯片尺寸 Chip Size (mil)	45
光源数量 Light Source Quantity (pcs)	4 / 3
光源光效 Luminous Efficiency (Lm/W)	90-130
显色指数 CRI	80
色温 Color Temp (k)	2800-7000
环境温度 Environment Temperature (°C)	-40~45
使用寿命 Lifespan (h)	30000-80000

外形尺寸图 Dimension Diagram

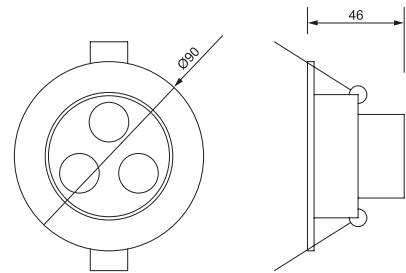
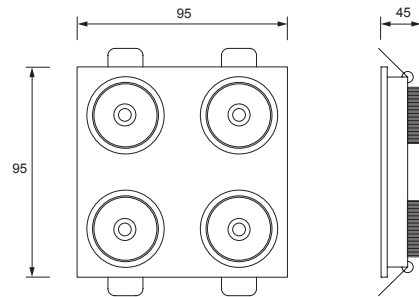

包装参数 Packaging Parameters

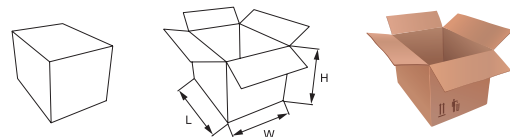

Item	Size(mm)	包装数量 Qty	外箱尺寸 Carton Size
BSD-TH042		100PCS	545L×545W×380H
BSD-TH043		100PCS	520L×520W×380H

LED 天花板灯

LED Ceiling Light

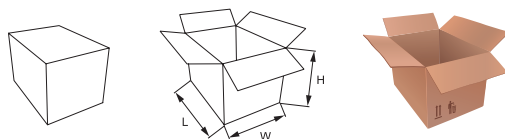
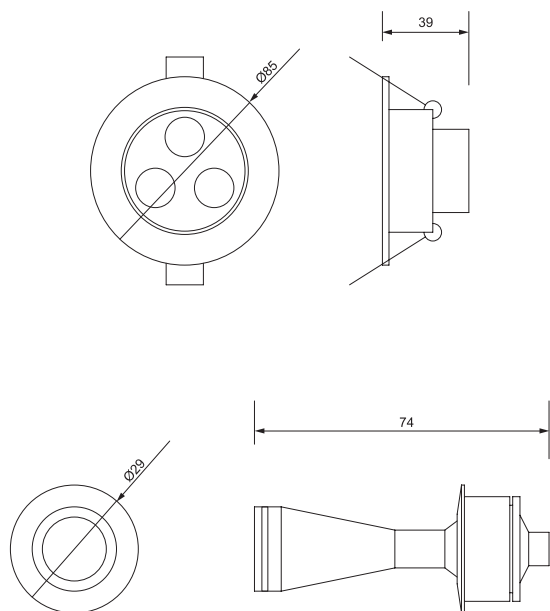

Item	Size(mm)	包装数量 Qty	外箱尺寸 Carton Size
BSD-TH044		100PCS	520L×520W×380H
BSD-TH045		100PCS	420L×220W×340H

白光LED的能耗仅为白炽灯的1/10，节能灯的1/4，寿命长，寿命可达10万小时以上，采用固态封装，采用铝材成型，良好的散热结构，属于冷光源类型，安装和运输都很方便，表面温度低，无明火隐患。

Energy saving, the energy consumption of white-light LED takes only 1/10 of filament lamp, and 1/4 of energy saving lamp. Long lifespan, more than 100,000 hours. Using solid encapsulation, aluminum molding, excellent heat dissipation, cold light source, easy installation and convenient delivery, low surface temperature and no fire hazards.

适用于汽车展示、珠宝首饰、高档服饰、专业橱窗、柜台等重点照明场所。

Apply to car, jewelry and high-end dress and professional showcase, sales counter showing and important lighting areas.

型号 Type	TH044 / TH045
材料 Material	Al
防护等级 IP Rating	IP40
功率 Power (W)	3W / 1W
输入电压 Input Voltage (V)	85-265
光源类型 Light source Type	high power LED
芯片尺寸 Chip Size (mil)	45
光源数量 Light Source Quantity (pcs)	3 / 1
光源光效 Luminous Efficiency (Lm/W)	90-130
显色指数 CRI	80
色温 Color Temp (k)	2800-7000
环境温度 Environment Temperature (°C)	-40~45
使用寿命 Lifespan (h)	30000-80000



LED 天花灯

LED Ceiling Light

BSD-TH046

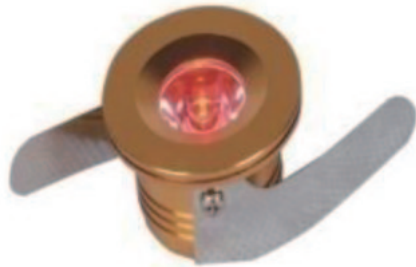

BSD-TH047



产品特点 Product Features

白光LED的能耗仅为白炽灯的1/10, 节能灯的1/4, 寿命长, 寿命可达10万小时以上, 采用固态封装, 采用铝材成型, 良好的散热结构, 属于冷光源类型, 安装和运输都很方便, 表面温度低, 无明火隐患。

Energy saving, the energy consumption of white-light LED takes only 1/10 of filament lamp, and 1/4 of energy saving lamp. Long lifespan, more than 100,000 hours. Using solid encapsulation, aluminum molding, excellent heat dissipation, cold light source, easy installation and convenient delivery, low surface temperature and no fire hazards.

应用场合 Applications

适用于汽车展示、珠宝首饰、高档服饰、专业橱窗、柜台等重点照明场所。

Apply to car, jewelry and high-end dress and professional showcase, sales counter showing and important lighting areas.

规格参数 Specifications

型号 Type	TH046 / TH047
材料 Material	Al
防护等级 IP Rating	IP40
功率 Power (W)	1W / 1W
输入电压 Input Voltage (V)	85-265
光源类型 Light source Type	high power LED
芯片尺寸 Chip Size (mil)	45
光源数量 Light Source Quantity (pcs)	1 / 1
光源光效 Luminous Efficiency (Lm/W)	90-130
显色指数 CRI	80
色温 Color Temp (k)	2800-7000
环境温度 Environment Temperature (°C)	-40~45
使用寿命 Lifespan (h)	30000-80000

外形尺寸图 Dimension Diagram

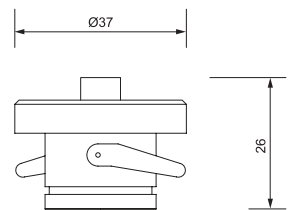
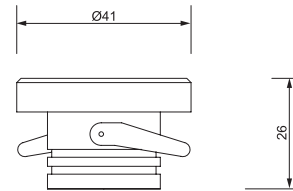

包装参数 Packaging Parameters

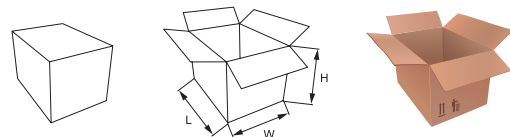

Item	Size(mm)	包装数量 Qty	外箱尺寸 Carton Size
BSD-TH046		100PCS	320L×320W×160H
BSD-TH047		100PCS	420L×270W×160H

LED 天花灯

LED Ceiling Light

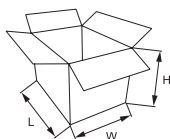
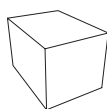
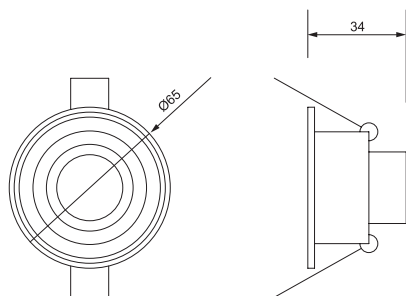
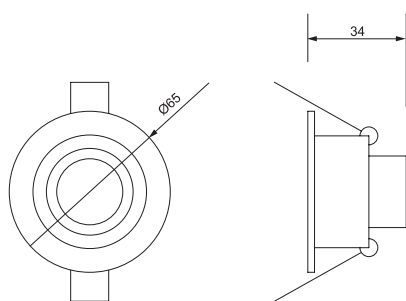

Item	Size(mm)	包装数量 Qty	外箱尺寸 Carton Size
BSD-TH048		100PCS	390L×390W×315H
BSD-TH049		100PCS	390L×390W×315H

白光LED的能耗仅为白炽灯的1/10，节能灯的1/4，寿命长，寿命可达10万小时以上，采用固态封装，采用铝材成型，良好的散热结构，属于冷光源类型，安装和运输都很方便，表面温度低，无明火隐患。

Energy saving, the energy consumption of white-light LED takes only 1/10 of filament lamp, and 1/4 of energy saving lamp. Long lifespan, more than 100,000 hours. Using solid encapsulation, aluminum molding, excellent heat dissipation, cold light source, easy installation and convenient delivery, low surface temperature and no fire hazards.

适用于汽车展示、珠宝首饰、高档服饰、专业橱窗、柜台等重点照明场所。

Apply to car, jewelry and high-end dress and professional showcase, sales counter showing and important lighting areas.

型号 Type	TH048 / TH049
材料 Material	Al
防护等级 IP Rating	IP40
功率 Power (W)	1W / 1W
输入电压 Input Voltage (V)	85-265
光源类型 Light source Type	high power LED
芯片尺寸 Chip Size (mil)	45
光源数量 Light Source Quantity (pcs)	1 / 1
光源光效 Luminous Efficiency (Lm/W)	90-130
显色指数 CRI	80
色温 Color Temp (k)	2800-7000
环境温度 Environment Temperature (°C)	-40~45
使用寿命 Lifespan (h)	30000-80000



LED 天花灯

LED Ceiling Light

BSD-TH050



BSD-TH051



产品特点 Product Features

白光LED的能耗仅为白炽灯的1/10, 节能灯的1/4, 寿命长, 寿命可达10万小时以上, 采用固态封装, 采用铝材成型, 良好的散热结构, 属于冷光源类型, 安装和运输都很方便, 表面温度低, 无明火隐患。

Energy saving, the energy consumption of white-light LED takes only 1/10 of filament lamp, and 1/4 of energy saving lamp. Long lifespan, more than 100,000 hours. Using solid encapsulation, aluminum molding, excellent heat dissipation, cold light source, easy installation and convenient delivery, low surface temperature and no fire hazards.

应用场合 Applications

适用于汽车展示、珠宝首饰、高档服饰、专业橱窗、柜台等重点照明场所。

Apply to car, jewelry and high-end dress and professional showcase, sales counter showing and important lighting areas.

规格参数 Specifications

型号 Type	TH050 / TH051
材料 Material	Al
防护等级 IP Rating	IP40
功率 Power (W)	3W / 3W
输入电压 Input Voltage (V)	85-265
光源类型 Light source Type	high power LED
芯片尺寸 Chip Size (mil)	45
光源数量 Light Source Quantity (pcs)	3 / 3
光源光效 Luminous Efficiency (Lm/W)	90-130
显色指数 CRI	80
色温 Color Temp (k)	2800-7000
环境温度 Environment Temperature (°C)	-40~45
使用寿命 Lifespan (h)	30000-80000

外形尺寸图 Dimension Diagram

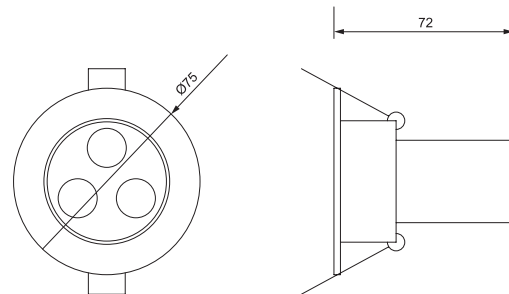
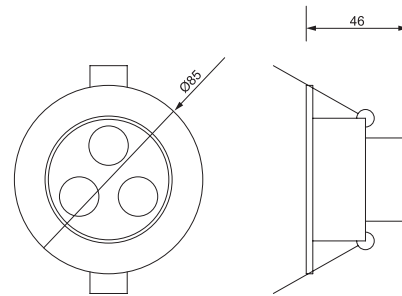

包装参数 Packaging Parameters

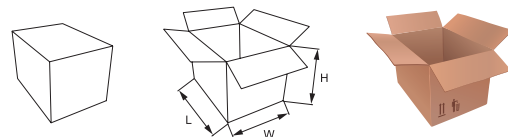

Item	Size(mm)	包装数量 Qty	外箱尺寸 Carton Size
BSD-TH050		100PCS	495L×495W×380H
BSD-TH051		100PCS	470L×470W×380H

LED 天花板灯

LED Ceiling Light

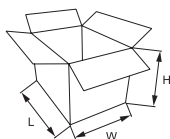
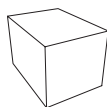
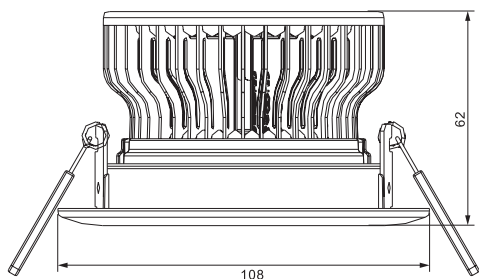
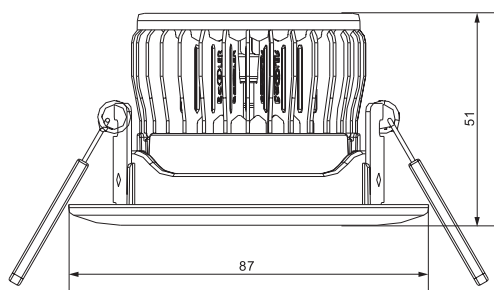

Item	Size(mm)	包装数量 Qty	外箱尺寸 Carton Size
BSD-TH052		80PCS	420L×420W×320H
BSD-TH053		80PCS	500L×500W×370H

白光LED的能耗仅为白炽灯的1/10，节能灯的1/4，寿命长，寿命可达10万小时以上，采用固态封装，采用铝材成型，良好的散热结构，属于冷光源类型，安装和运输都很方便，表面温度低，无明火隐患。

Energy saving, the energy consumption of white-light LED takes only 1/10 of filament lamp, and 1/4 of energy saving lamp. Long lifespan, more than 100,000 hours. Using solid encapsulation, aluminum molding, excellent heat dissipation, cold light source, easy installation and convenient delivery, low surface temperature and no fire hazards.

适用于汽车展示、珠宝首饰、高档服饰、专业橱窗、柜台等重点照明场所。

Apply to car, jewelry and high-end dress and professional showcase, sales counter showing and important lighting areas.

型号 Type	TH052 / TH053
材料 Material	Al
防护等级 IP Rating	IP40
功率 Power (W)	3W / 5W
输入电压 Input Voltage (V)	85-265
光源类型 Light source Type	high power LED
芯片尺寸 Chip Size (mil)	45
光源数量 Light Source Quantity (pcs)	3 / 5
光源光效 Luminous Efficiency (Lm/W)	90-130
显色指数 CRI	80
色温 Color Temp (k)	2800-7000
环境温度 Environment Temperature (°C)	-40~45
使用寿命 Lifespan (h)	30000-80000



LED 天花灯

LED Ceiling Light

BSD-TH054



BSD-TH055



产品特点 Product Features

白光LED的能耗仅为白炽灯的1/10, 节能灯的1/4, 寿命长, 寿命可达10万小时以上, 采用固态封装, 采用铝材成型, 良好的散热结构, 属于冷光源类型, 安装和运输都很方便, 表面温度低, 无明火隐患。

Energy saving, the energy consumption of white-light LED takes only 1/10 of filament lamp, and 1/4 of energy saving lamp. Long lifespan, more than 100,000 hours. Using solid encapsulation, aluminum molding, excellent heat dissipation, cold light source, easy installation and convenient delivery, low surface temperature and no fire hazards.

应用场合 Applications

适用于汽车展示、珠宝首饰、高档服饰、专业橱窗、柜台等重点照明场所。

Apply to car, jewelry and high-end dress and professional showcase, sales counter showing and important lighting areas.

规格参数 Specifications

型号 Type	TH054 / TH055
材料 Material	Al
防护等级 IP Rating	IP40
功率 Power (W)	7W / 9W
输入电压 Input Voltage (V)	85-265
光源类型 Light source Type	high power LED
芯片尺寸 Chip Size (mil)	45
光源数量 Light Source Quantity (pcs)	7 / 9
光源光效 Luminous Efficiency (Lm/W)	90-130
显色指数 CRI	80
色温 Color Temp (k)	2800-7000
环境温度 Environment Temperature (°C)	-40~45
使用寿命 Lifespan (h)	30000-80000

外形尺寸图 Dimension Diagram

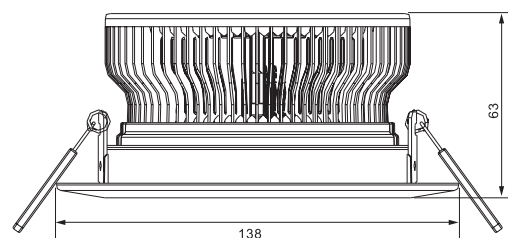
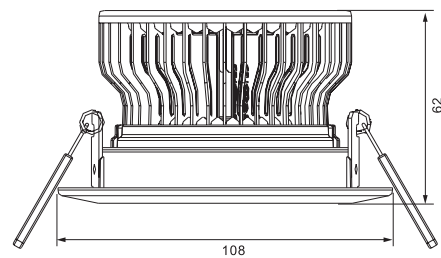

包装参数 Packaging Parameters

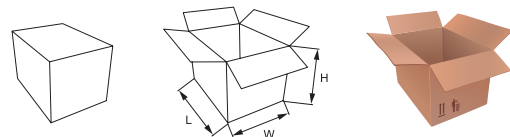

Item	Size(mm)	包装数量 Qty	外箱尺寸 Carton Size
BSD-TH054		80PCS	500L×500W×370H
BSD-TH055		45PCS	470L×470W×395H

LED 天花灯

LED Ceiling Light

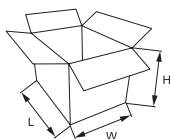
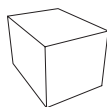
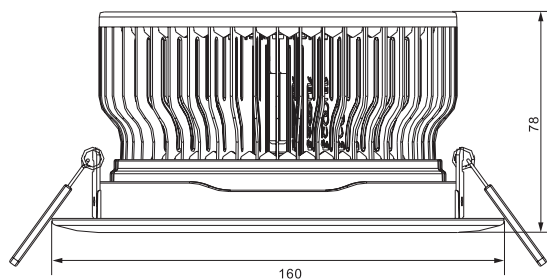
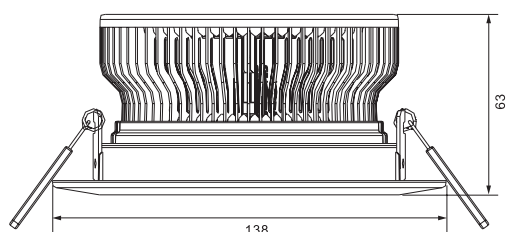

Item	Size(mm)	包装数量 Qty	外箱尺寸 Carton Size
BSD-TH056		45PCS	470L×470W×395H
BSD-TH057		45PCS	530L×530W×450H

白光LED的能耗仅为白炽灯的1/10，节能灯的1/4，寿命长，寿命可达10万小时以上，采用固态封装，采用铝材成型，良好的散热结构，属于冷光源类型，安装和运输都很方便，表面温度低，无明火隐患。

Energy saving, the energy consumption of white-light LED takes only 1/10 of filament lamp, and 1/4 of energy saving lamp. Long lifespan, more than 100,000 hours. Using solid encapsulation, aluminum molding, excellent heat dissipation, cold light source, easy installation and convenient delivery, low surface temperature and no fire hazards.

适用于汽车展示、珠宝首饰、高档服饰、专业橱窗、柜台等重点照明场所。

Apply to car, jewelry and high-end dress and professional showcase, sales counter showing and important lighting areas.

型号 Type	TH056 / TH057
材料 Material	Al
防护等级 IP Rating	IP40
功率 Power (W)	12W / 15W
输入电压 Input Voltage (V)	85-265
光源类型 Light source Type	high power LED
芯片尺寸 Chip Size (mil)	45
光源数量 Light Source Quantity (pcs)	12 / 15
光源光效 Luminous Efficiency (Lm/W)	90-130
显色指数 CRI	80
色温 Color Temp (k)	2800-7000
环境温度 Environment Temperature (°C)	-40~45
使用寿命 Lifespan (h)	30000-80000