



# LED 筒灯

## LED Down Light



### 外形尺寸图 Dimension Diagram

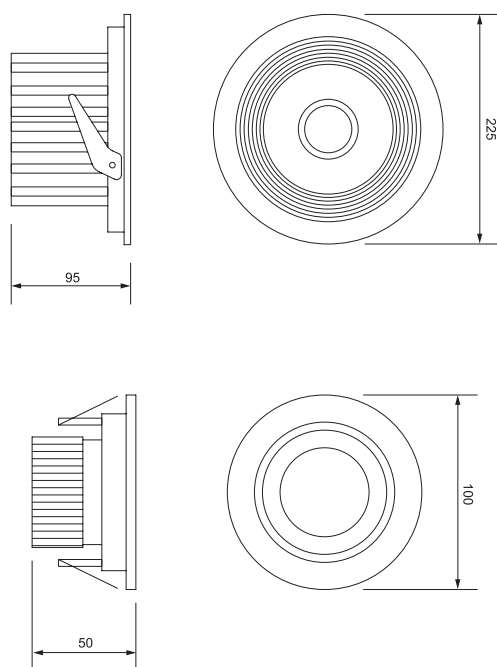

### 包装参数 Packaging Parameters

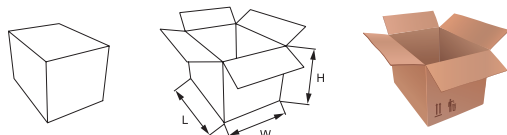

Item	Size(mm)	包装数量 Qty	外箱尺寸 Carton Size
BSD-TD058		16PCS	515L×515W×620H
BSD-TD059		100PCS	620L×620W×520H

### 产品特点 Product Features

光线柔和, 光谱纯正, 发光效率高, 照度均匀性良好, 对眼睛无刺激性. 导热面与空气的接触面积大, 散热效果好, 具有过压保护、过流保护和短路保护等功能, 安全可靠。

Soft light, pure optical spectrum, high luminous efficiency, excellent illumination uniformity, no irritation to eyes. Big contact area between thermal surface and atmosphere, superior heat dissipation performance, overvoltage, overcurrent and short circuit protection, safe and reliable.

### 应用场合 Applications

用于商场、办公大楼、酒店、展厅、会议室、医院、橱窗、居室等场所, 特别适合豪华型高标准大空间的照明装饰。

Apply to market, office building, hotel, exhibition room, meeting room, hospital, show window, living room, etc. Especially suitable for lighting decoration of big luxurious high-standard place, etc.

### 规格参数 Specifications

型号 Type	TD058 / TD059
材料 Material	Al
防护等级 IP Rating	IP40
功率 Power (W)	15W / 3W
输入电压 Input Voltage (V)	85-265
光源类型 Light source Type	COB LED
芯片尺寸 Chip Size (mil)	12*12
光源数量 Light Source Quantity (pcs)	1 / 1
光源光效 Luminous Efficiency (Lm/W)	90-130
显色指数 CRI	80
色温 Color Temp (k)	2800-7000
环境温度 Environment Temperature (°C)	-40~45
使用寿命 Lifespan (h)	30000-80000



# LED 筒灯

## LED Down Light

**BSD-TD01**



**BSD-TD06**



### 产品特点 Product Features

光线柔和, 光谱纯正, 发光效率高, 照度均匀性良好, 对眼睛无刺激性. 导热面与空气的接触面积大, 散热效果好, 具有过压保护、过流保护和短路保护等功能, 安全可靠。

Soft light, pure optical spectrum, high luminous efficiency, excellent illumination uniformity, no irritation to eyes. Big contact area between thermal surface and atmosphere, superior heat dissipation performance, overvoltage, overcurrent and short circuit protection, safe and reliable.

### 应用场合 Applications

用于商场、办公大楼、酒店、展厅、会议室、医院、橱窗、居室等场所, 特别适合豪华型高标准大空间的照明装饰。

Apply to market, office building, hotel, exhibition room, meeting room, hospital, show window, living room, etc. Especially suitable for lighting decoration of big luxurious high-standard place, etc.

### 规格参数 Specifications

型号 Type	TD060 / TD061
材料 Material	Al
防护等级 IP Rating	IP40
功率 Power (W)	3W / 5W
输入电压 Input Voltage (V)	85-265
光源类型 Light source Type	COB LED
芯片尺寸 Chip Size (mil)	12*12
光源数量 Light Source Quantity (pcs)	1 / 1
光源光效 Luminous Efficiency (Lm/W)	90-130
显色指数 CRI	80
色温 Color Temp (k)	2800-7000
环境温度 Environment Temperature (°C)	-40~45
使用寿命 Lifespan (h)	30000-80000

### 外形尺寸图 Dimension Diagram

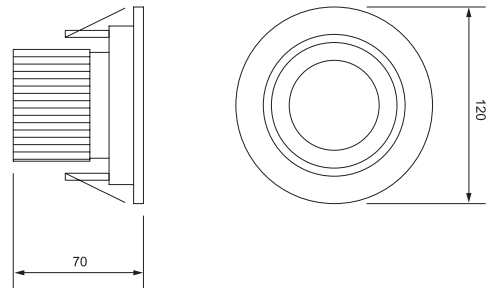
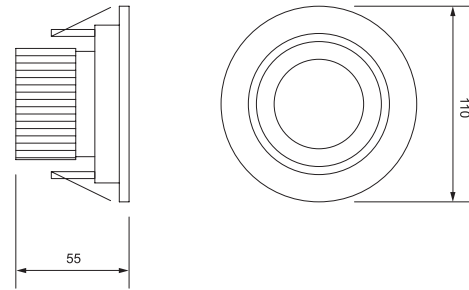

### 包装参数 Packaging Parameters

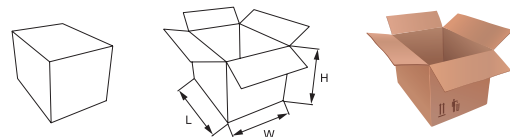

Item	Size(mm)	包装数量 Qty	外箱尺寸 Carton Size
BSD-TD060		100PCS	620L×620W×520H
BSD-TD061		100PCS	670L×670W×520H

# LED 筒灯

## LED Down Light



### 外形尺寸图 Dimension Diagram

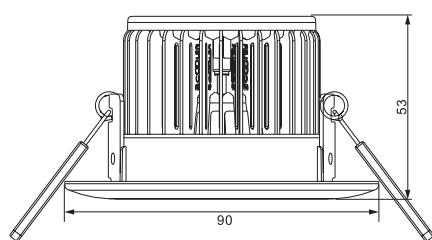
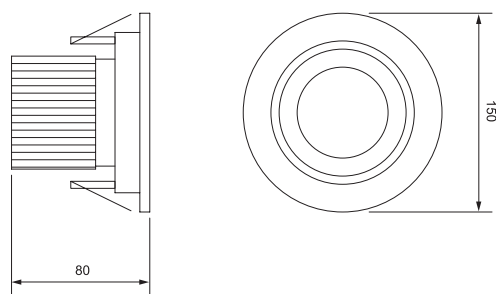

### 包装参数 Packaging Parameters

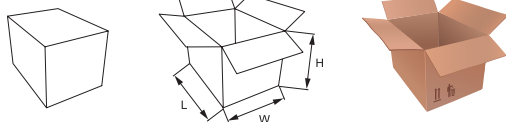

Item	Size(mm)	包装数量 Qty	外箱尺寸 Carton Size
BSD-TD062		45PCS	615L×615W×520H
BSD-TD063		100PCS	520L×520W×260H

### 产品特点 Product Features

光线柔和, 光谱纯正, 发光效率高, 照度均匀性良好, 对眼睛无刺激性. 导热面与空气的接触面积大, 散热效果好, 具有过压保护、过流保护和短路保护等功能, 安全可靠。

Soft light, pure optical spectrum, high luminous efficiency, excellent illumination uniformity, no irritation to eyes. Big contact area between thermal surface and atmosphere, superior heat dissipation performance, overvoltage, overcurrent and short circuit protection, safe and reliable.

### 应用场合 Applications

用于商场、办公大楼、酒店、展厅、会议室、医院、橱窗、居室等场所, 特别适合豪华型高标准大空间的照明装饰。

Apply to market, office building, hotel, exhibition room, meeting room, hospital, show window, living room, etc. Especially suitable for lighting decoration of big luxurious high-standard place, etc.

### 规格参数 Specifications

型号 Type	TD062 / TD063
材料 Material	Al
防护等级 IP Rating	IP40
功率 Power (W)	7W / 3W
输入电压 Input Voltage (V)	85-265
光源类型 Light source Type	COB LED / high power LED
芯片尺寸 Chip Size (mil)	12*12 / 45
光源数量 Light Source Quantity (pcs)	1 / 3
光源光效 Luminous Efficiency (Lm/W)	90-130
显色指数 CRI	80
色温 Color Temp (k)	2800-7000
环境温度 Environment Temperature (°C)	-40~45
使用寿命 Lifespan (h)	30000-80000



# LED 筒灯

## LED Down Light

**BSD-TD064**



**BSD-TD065**



### 产品特点 Product Features

光线柔和, 光谱纯正, 发光效率高, 照度均匀性良好, 对眼睛无刺激性. 导热面与空气的接触面积大, 散热效果好, 具有过压保护、过流保护和短路保护等功能, 安全可靠。

Soft light, pure optical spectrum, high luminous efficiency, excellent illumination uniformity, no irritation to eyes. Big contact area between thermal surface and atmosphere, superior heat dissipation performance, overvoltage, overcurrent and short circuit protection, safe and reliable.

### 应用场合 Applications

用于商场、办公大楼、酒店、展厅、会议室、医院、橱窗、居室等场所, 特别适合豪华型高标准大空间的照明装饰。

Apply to market, office building, hotel, exhibition room, meeting room, hospital, show window, living room, etc. Especially suitable for lighting decoration of big luxurious high-standard place, etc.

### 规格参数 Specifications

型号 Type	TD064 / TD065
材料 Material	Al
防护等级 IP Rating	IP40
功率 Power (W)	7W / 15W
输入电压 Input Voltage (V)	85-265
光源类型 Light source Type	high power LED
芯片尺寸 Chip Size (mil)	45
光源数量 Light Source Quantity (pcs)	7 / 15
光源光效 Luminous Efficiency (Lm/W)	90-130
显色指数 CRI	80
色温 Color Temp (k)	2800-7000
环境温度 Environment Temperature (°C)	-40~45
使用寿命 Lifespan (h)	30000-80000

### 外形尺寸图 Dimension Diagram

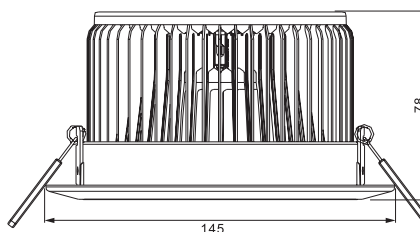
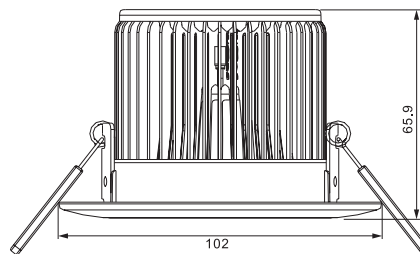

### 包装参数 Packaging Parameters

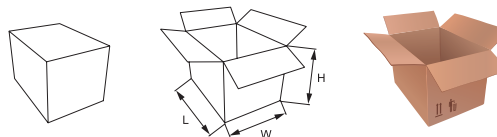

Item	Size(mm)	包装数量 Qty	外箱尺寸 Carton Size
BSD-TD064		80PCS	460L×460W×420H
BSD-TD065		45PCS	485L×485W×470H

# LED 筒灯

## LED Down Light



### 外形尺寸图 Dimension Diagram

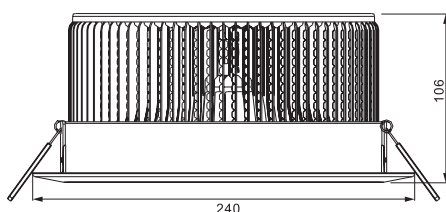
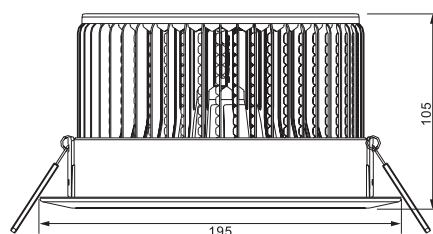

### 包装参数 Packaging Parameters

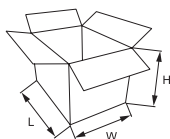
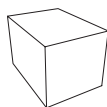

Item	Size(mm)	包装数量 Qty	外箱尺寸 Carton Size
BSD-TD066		16PCS	430L×430W×480H
BSD-TD067		16PCS	520L×520W×500H

### 产品特点 Product Features

光线柔和, 光谱纯正, 发光效率高, 照度均匀性良好, 对眼睛无刺激性. 导热面与空气的接触面积大, 散热效果好, 具有过压保护、过流保护和短路保护等功能, 安全可靠。

Soft light, pure optical spectrum, high luminous efficiency, excellent illumination uniformity, no irritation to eyes. Big contact area between thermal surface and atmosphere, superior heat dissipation performance, overvoltage, overcurrent and short circuit protection, safe and reliable.

### 应用场合 Applications

用于商场、办公大楼、酒店、展厅、会议室、医院、橱窗、居室等场所, 特别适合豪华型高标准大空间的照明装饰。

Apply to market, office building, hotel, exhibition room, meeting room, hospital, show window, living room, etc. Especially suitable for lighting decoration of big luxurious high-standard place, etc.

### 规格参数 Specifications

型号 Type	TD066 / TD067
材料 Material	Al
防护等级 IP Rating	IP40
功率 Power (W)	24W / 36W
输入电压 Input Voltage (V)	85-265
光源类型 Light source Type	high power LED
芯片尺寸 Chip Size (mil)	45
光源数量 Light Source Quantity (pcs)	24 / 36
光源光效 Luminous Efficiency (Lm/W)	90-130
显色指数 CRI	80
色温 Color Temp (k)	2800-7000
环境温度 Environment Temperature (°C)	-40~45
使用寿命 Lifespan (h)	30000-80000



# LED 平板灯

## LED Panel Light

**BSD-PB001**



**BSD-PB002**



### 产品特点 Product Features

比传统荧光灯节能75%以上，不含有害成分，可进行多次回收利用，使用寿命长，每天使用24小时可使用5年以上，无闪烁无眩光无紫外线，可减少眼部疲劳保护皮肤，安装方便。

More than 75% energy saving than traditional fluorescent lamp. Without harmful composition and multiple recycling. Lifespan can be reached 5 years with 24 hour daily use. No flicker, no glare and no ultraviolet, which can reduce eye fatigue and protect the skin. Easy installation.

### 应用场合 Applications

主要用于商场，工厂，学校，停车场，写字楼，医院等场合的照明。

Apply to shopping malls, factories, schools, parking lots, office buildings, hospitals etc.

### 规格参数 Specifications

型号 Type	PB001 / PB002
材料 Material	Al
防护等级 IP Rating	IP40
功率 Power (W)	36W / 28W
输入电压 Input Voltage (V)	85-265
光源类型 Light source Type	3014LED
芯片尺寸 Chip Size (mil)	10*23
光源数量 Light Source Quantity (pcs)	336 / 252
光源光效 Luminous Efficiency (Lm/W)	90-130
显色指数 CRI	80
色温 Color Temp (k)	2800-7000
环境温度 Environment Temperature (°C)	-40~45
使用寿命 Lifespan (h)	30000-80000

### 外形尺寸图 Dimension Diagram

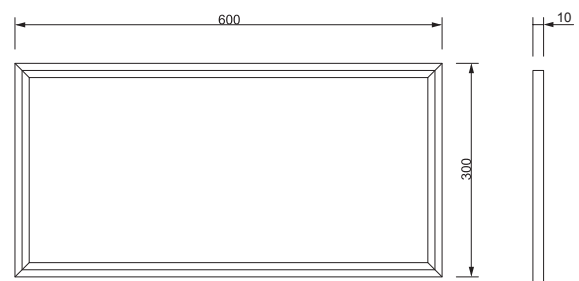
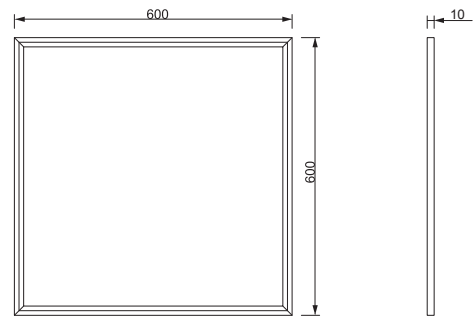

### 包装参数 Packaging Parameters

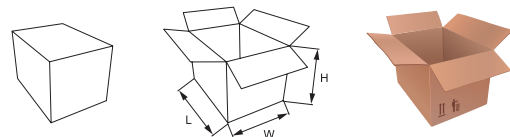

Item	Size(mm)	包装数量 Qty	外箱尺寸 Carton Size
BSD-PB001		10PCS	700L×530W×650H
BSD-PB002		10PCS	710L×530W×360H

# LED 平板灯



## LED Panel Light



**BSD-PB003**



**BSD-PB004**

### 外形尺寸图 Dimension Diagram

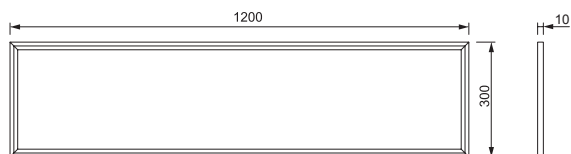
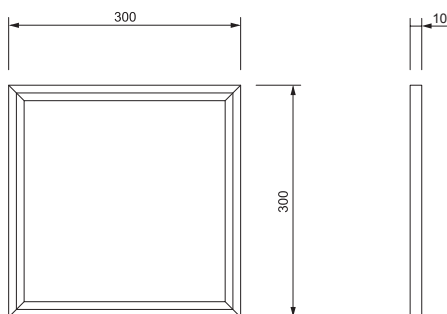

### 包装参数 Packaging Parameters

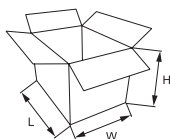
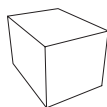

Item	Size(mm) 包装数量 Qty	外箱尺寸 Carton Size
BSD-PB003	20PCS	810L×530W×360H
BSD-PB004	10PCS	1310L×530W×360H

### 产品特点 Product Features

比传统荧光灯节能75%以上，不含有害成分，可进行多次回收利用，使用寿命长，每天使用24小时可使用5年以上，无闪烁无眩光无紫外线，可减少眼部疲劳保护皮肤，安装方便。

More than 75% energy saving than traditional fluorescent lamp. Without harmful composition and multiple recycling. Lifespan can be reached 5 years with 24 hour daily use. No flicker, no glare and no ultraviolet, which can reduce eye fatigue and protect the skin. Easy installation.

### 应用场合 Applications

主要用于商场，工厂，学校，停车场，写字楼，医院等场合的照明。

Apply to shopping malls, factories, schools, parking lots, office buildings, hospitals etc.

### 规格参数 Specifications

型号 Type	PB003 / PB004
材料 Material	Al
防护等级 IP Rating	IP40
功率 Power (W)	15W / 40W
输入电压 Input Voltage (V)	85-265
光源类型 Light source Type	3014LED
芯片尺寸 Chip Size (mil)	10*23
光源数量 Light Source Quantity (pcs)	120 / 160
光源光效 Luminous Efficiency (Lm/W)	90-130
显色指数 CRI	80
色温 Color Temp (k)	2800-7000
环境温度 Environment Temperature (°C)	-40~45
使用寿命 Lifespan (h)	30000-80000





# LED 平板灯

## LED Panel Light

**BSD-PB005**



**BSD-PB006**



### 产品特点 Product Features

比传统荧光灯节能75%以上，不含有害成分，可进行多次回收利用，使用寿命长，每天使用24小时可使用5年以上，无闪烁无眩光无紫外线，可减少眼部疲劳保护皮肤，安装方便。

More than 75% energy saving than traditional fluorescent lamp. Without harmful composition and multiple recycling. Lifespan can be reached 5 years with 24 hour daily use. No flicker, no glare and no ultraviolet, which can reduce eye fatigue and protect the skin. Easy installation.

### 应用场合 Applications

主要用于商场，工厂，学校，停车场，写字楼，医院等场合的照明。

Apply to shopping malls, factories, schools, parking lots, office buildings, hospitals etc.

### 规格参数 Specifications

型号 Type	PB005 / PB006
材料 Material	Al
防护等级 IP Rating	IP40
功率 Power (W)	12W / 22W
输入电压 Input Voltage (V)	85-265
光源类型 Light source Type	3014LED
芯片尺寸 Chip Size (mil)	10*23
光源数量 Light Source Quantity (pcs )	100 / 200
光源光效 Luminous Efficiency (Lm/W)	90-130
显色指数 CRI	80
色温 Color Temp (k)	2800-7000
环境温度 Environment Temperature (°C)	-40~45
使用寿命 Lifespan (h)	30000-80000

### 外形尺寸图 Dimension Diagram

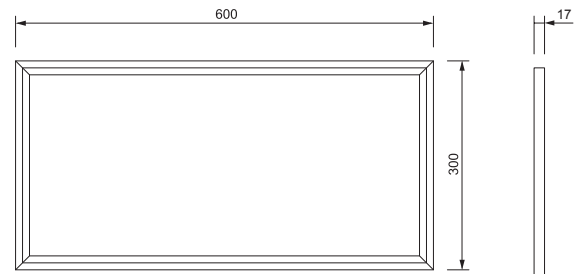
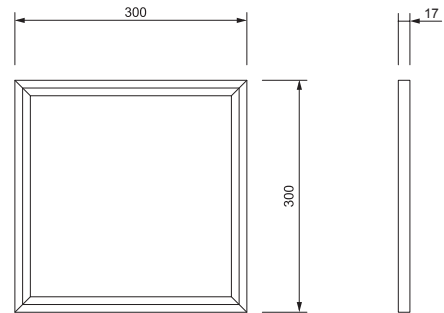

### 包装参数 Packaging Parameters

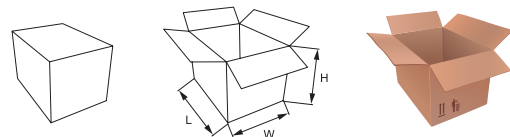

Item	Size(mm)	包装数量 Qty	外箱尺寸 Carton Size
BSD-PB005		10PCS	810L×530W×360H
BSD-PB006		10PCS	710L×530W×360H

# LED 格栅灯



## LED Grille Light

**BSD-GS001**



**BSD-GS002**

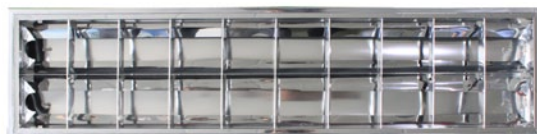

### 外形尺寸图 Dimension Diagram

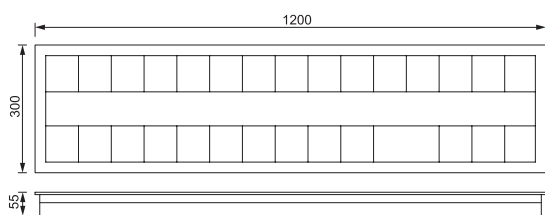
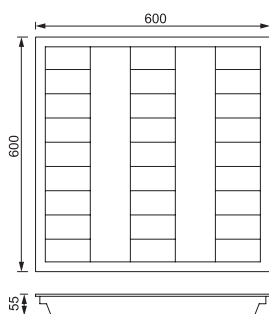

### 包装参数 Packaging Parameters

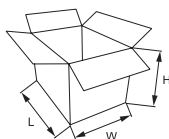
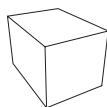

Item	Size(mm)	包装数量 Qty	外箱尺寸 Carton Size
BSD-GS001		2PCS	615L×615W×115H
BSD-GS002		2PCS	1212L×315W×115H

### 产品特点 Product Features

节能，同等功率下耗电仅为传统日光灯的30%，寿命长，24小时常开寿命长达六年，显色性好，可频繁开关，颜色丰富，发热量低。

Energy saving, at the same power level, the power consumption is only 30% of the traditional fluorescent lamp. Long lifespan, lifespan can be reached six years with 24 hours opening. High CRI, frequent switch, rich colors, low heat.

### 应用场合 Applications

适用于各类办公、地铁站、车站、商场等照明场所。

Apply to offices, metro stations, stations and store lighting places.

### 规格参数 Specifications

型号 Type	GS001 / GS002
材料 Material	Al
防护等级 IP Rating	IP40
功率 Power (W)	27W / 36W
输入电压 Input Voltage (V)	85-265
光源类型 Light source Type	3528LED
芯片尺寸 Chip Size (mil)	12*12
光源数量 Light Source Quantity (pcs)	3 / 2
光源光效 Luminous Efficiency (Lm/W)	90-130
显色指数 CRI	80
色温 Color Temp (k)	2800-7000
环境温度 Environment Temperature (°C)	-40~45
使用寿命 Lifespan (h)	30000-80000